

Roland

MIDI POLYPHONIC SYNTHESIZER SUPER JX

MKS-70

Owner's Manual

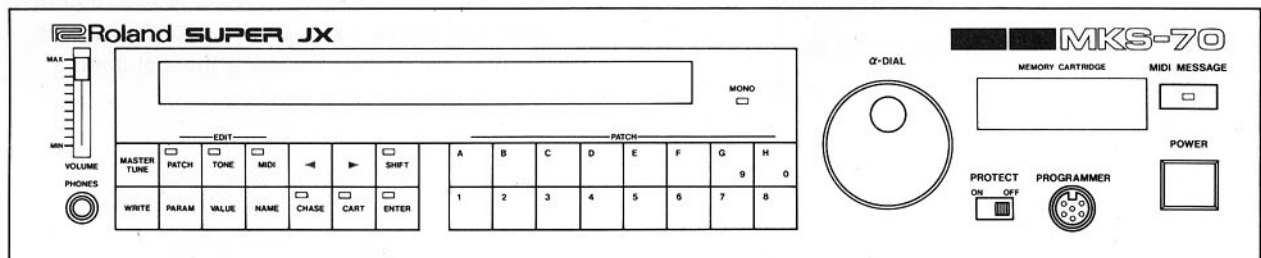

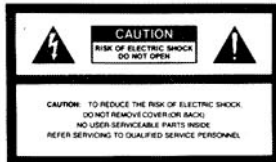

The lightning flash with arrowhead symbol, within an equilateral triangle, is intended to alert the user to the presence of un-insulated "dangerous voltage" within the product's enclosure that may be of sufficient magnitude to constitute a risk of electric shock to persons.



The exclamation point within an equilateral triangle is intended to alert the user to the presence of important operating and maintenance (servicing) instructions in the literature accompanying the product.

INSTRUCTIONS PERTAINING TO A RISK OF FIRE, ELECTRIC SHOCK OR INJURY TO PERSONS.

IMPORTANT SAFETY INSTRUCTIONS

WARNING When using electric products, basic precautions should always be followed, including the following;

1. Read all the instructions before using the product.
2. To reduce the risk of injury, close supervision is necessary when a product is used near children.
3. Do not use this product near water- for example, near a bathtub, washbowl, kitchen sink, in a wet basement, or near a swimming pool, or the like.
4. This product should be used only with a cart or stand that is recommended by the manufacturer.
5. This product, either alone or in combination with an amplifier and headphones or speakers, may be capable of producing sound levels that could cause permanent hearing loss.
Do not operate for a long period of time at a high volume level or at level that is uncomfortable. If you experience any hearing loss or ringing in the ears, you should consult an audiologist.
6. The product should be located so that its location or position does not interfere with its proper ventilation.
7. The product should be located away from heat sources such as radiators, heat registers or other products that produce heat.
8. The product should avoid using in where it may be effected by dust.
9. The product should be connected to a power supply only of the type described in the operating instructions or as marked on the product.
10. The power-supply cord of the product should be unplugged from the outlet when left unused for a long period of time.
11. Do not tread on the power-supply cord.
12. Do not pull the cord but hold the plug when unplugging.
13. When setting up with any other instruments, the procedure should be followed in accordance with instruction manual.
14. Care should be taken so that objects do not fall and liquids are not spilled into the enclosure through openings.
15. The product should be serviced by qualified service personnel when:
 - A: The power-supply cord or the plug has been damaged; or
 - B: Objects have fallen, or liquid has been spilled into the product; or
 - C: The product has been exposed to rain; or
 - D: The product does not appear to operate normally or exhibits a marked change in performance; or
 - E: The product has been dropped, or the enclosure damaged.
16. Do not attempt to service the product beyond that described in the user-maintenance instructions. All other servicing should be referred to qualified service personnel.

SAVE THESE INSTRUCTIONS

ADVARSEL !

Lithiumbatteri. Eksplosionsfare.
Udskiftning må kun foretages af en sagkyndig,
og som beskrevet i servicemanual.

VARNING !

Lithiumbatteri. Eksplosionsrisk.
Får endast bytas av behörig servicetekniker.
Se instruktioner i servicemanualen.

ADVARSEL !

Lithiumbatteri. Fare for eksplosion.
Må bare skiftes av kvalifisert tekniker som
beskrevet i servicemanualen.

VAROITUS !

Lithiumparisto. Räjähdyksvaara.
Pariston saa vaihtaa ainoastaan
alan ammottimies.

WARNING

THIS APPARATUS MUST BE EARTH GROUNDDED.

The three conductors of the mains lead attached to this apparatus are identified with color as shown in the table below, together with the matching terminal on the UK type power plug. When connecting the mains lead to a plug, be sure to connect each conductor to the correct terminal, as indicated.
"This instruction applies to the product for United Kingdom."

MAINS LEADS		PLUG
Conductor	Color	Mark on the matching terminal
Live	Brown	Red or letter L
Neutral	Blue	Black or letter N
Grounding	Green-Yellow	Green, Green-Yellow, letter E or symbol

Bescheinigung des Herstellers /Importeurs

Hiermit wird bescheinigt, daß der/die/das

ROLAND PROGRAMMABLE POLYPHONIC SYNTHESIZER MKS-70
(Gerät, Typ, Bezeichnung)

in Übereinstimmung mit den Bestimmungen der

Amtsbl. Vfg 1046 / 1984

(Amtsblattverfügung)

funk-entstört ist.

Der Deutschen Bundespost wurde das Inverkehrbringen dieses Gerätes angezeigt und die Berechtigung zur Überprüfung der Serie auf Einhaltung der Bestimmungen eingeräumt.

Roland Corporation Osaka / Japan

Name des Herstellers/Importeurs

RADIO AND TELEVISION INTERFERENCE

"Warning - This equipment has been verified to comply with the limits for a Class B computing device, pursuant to Subpart J, of Part 15, of FCC rules. Operation with non-certified or non-verified equipment is likely to result in interference to radio and TV reception."

The equipment described in this manual generates and uses radio-frequency energy. If it is not installed and used properly, that is, in strict accordance with our instructions, it may cause interference with radio and television reception.

This equipment has been tested and found to comply with the limits for a Class B computing device in accordance with the specifications in Subpart J, of Part 15, of FCC Rules. These rules are designed to provide reasonable protection against such a interference in a residential installation. However, there is no guarantee that the interference will not occur in a particular installation. If this equipment does cause interference to radio or television reception, which can be determined by turning the equipment on and off, the user is encouraged to try to correct the interference by the following measure:

- Disconnect other devices and their input/output cables one at a time. If the interference stops, it is caused by either the other device or its I/O cable.
- These devices usually require Roland designated shielded I/O cables. For Roland devices, you can obtain the proper shielded cable from your dealer. For non-Roland devices, contact the manufacturer or dealer for assistance.

If your equipment does cause interference to radio or television reception, you can try to correct the interference by using one or more of the following measures:

- Turn the TV or radio antenna until the interference stops.
- Move the equipment to one side or the other of the TV or radio.
- Move the equipment farther away from the TV or radio. (That is, make certain the equipment and the radio or television set are on circuits controlled by different circuit breakers or fuses.)
- Consider installing a rooftop television antenna with coaxial cable lead-in between the antenna and TV.

If necessary, you should consult your dealer or an experienced radio/television technician for additional suggestions. You may find helpful the following booklet prepared by the Federal Communications Commission:

"How to Identify and Resolve Radio-TV Interference Problems"
This booklet is available from the U.S. Government Printing Office, Washington, D.C., 20402, Stock No. 004-000-00345-4.

Please read the separate volume "MIDI", before reading this owner's manual.

Copyright © 1986 by ROLAND CORPORATION

All rights reserved. No part of this publication may be reproduced in any form without the written permission of ROLAND CORPORATION.

Panel Description

• Front Panel

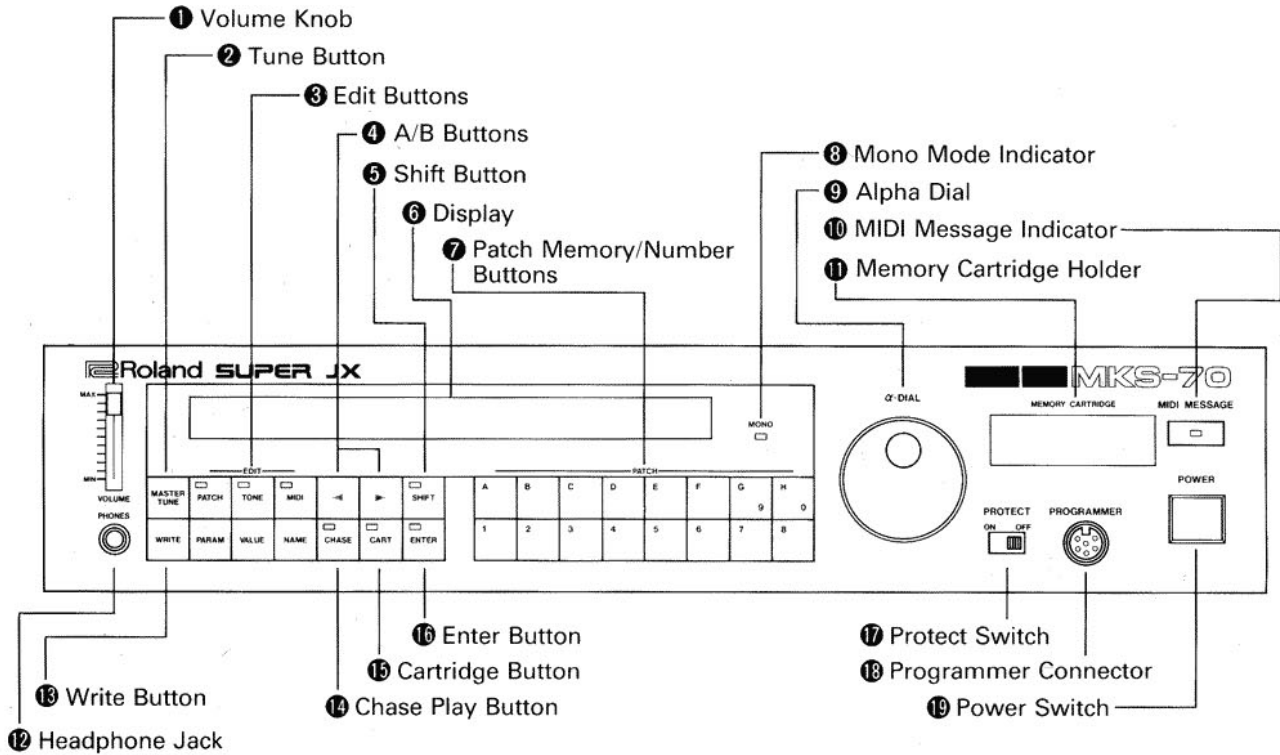

• Rear Panel

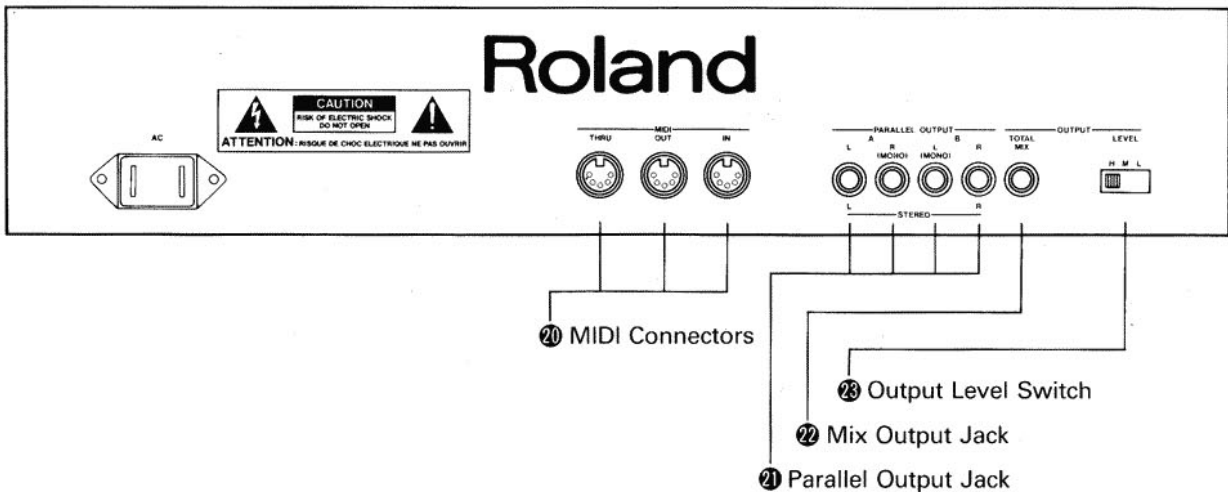

FEATURES

- The MKS-70 features the memory capacity that can store up to 64 different programs (Patches) which are the combinations of sounds and performance control functions. Any of these Patches can be called instantaneously by pushing relevant buttons.
 - Provided with six Key Modes, the MKS-70 allows wide variety of performance effects.
 - The Chase Playing function makes it possible to output two sounds in slightly shifted timing.
 - The MIDI Mono Mode makes the MSK-70 useful for the Guitar Controller.
 - Using the Memory Cartridge, the memory capacity can be easily expanded.
 - The Alpha Dial serves to make the operation quicker.
 - Using the Programmer PG-800, you can synthesize sounds much easier and quicker.
 - The 32 figure Fluorescent Indicator Panel Display can be clearly seen even in dark place.
 - The five output jacks serve to create a huge stereo space.
-

IMPORTANT NOTES

- The appropriate power supply for this unit is shown on its name plate. Please make sure that the line voltage in your country meets the requirement.
- Please do not use the same socket used for any noise generating device (such as motor, variable lighting system).
- This unit might not work properly if turned on immediately after turned off. If this happens, simply turn it off and turn it on again a few seconds later.
- Before setting up this unit with other devices, turn this unit and all the other units off.
- This unit might be heated while operating, but there is no need to worry about it.
- Use a soft cloth and clean only with a mild detergent.
- Do not use solvents such as paint thinner.
- Avoid using this unit in excessive heat or humidity or where it may be affected by direct sunlight or dust.
- Operating this unit near a neon, fluorescent lamp, TV or CRT Display may cause noise interference. If so, change the angle or the position of the unit.
- The MKS-70 features memory back-up system that retains the data even when switched off. The battery that supports the back-up circuit should be replaced every five years. Call for the Roland service station for the battery replacement. (The first replacement may be required before five years, depending on how long it had passed before you purchased the unit.)
- Please make a memo of the data or save it onto cartridge before having the MKS-70 repaired. There is no way for restoring the lost data.

CONTENTS

Panel Description	3
Important Notes	4
Connection	6
1 Outline of the MKS-70	8
2 Operation	10
1. MKS-70's Three Operation Modes	10
2. Playing Mode	11
a. Setting MIDI Channel	11
b. Patch Selection	13
c. Key Mode	14
d. Quick Edit	18
e. Function Display	20
f. Tuning	20
3. Editing Mode	21
a. Tone Editing	21
b. Patch Editing	29
c. Naming	36
d. Setting MIDI Functions	37
4. Writing Mode	40
a. Writing a Tone	42
b. Writing a Patch	42
c. Writing MIDI Functions	43
d. Saving and Loading	43
5. System Exclusive	44
3 Error Messages	46
Specifications	53

CONNECTION

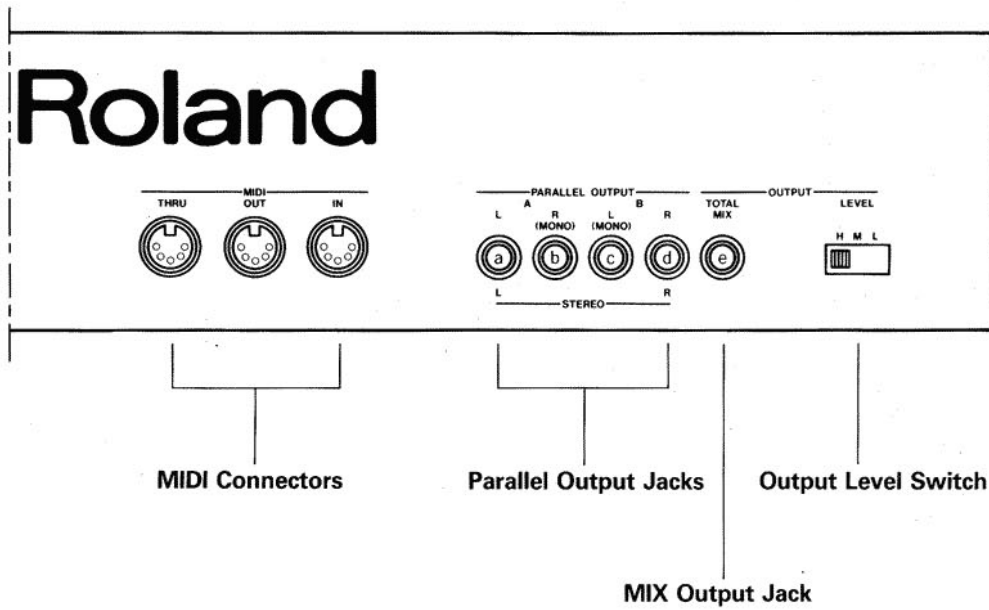

- ① Connect the MIDI OUT connector on the transmitter to the MIDI IN connector on the MKS-70 using the supplied MIDI cable.
- ② Connect the Output Jack on the MKS-70 to the input jack on the amplifier using the supplied audio cable.

● **MIDI Connectors**

IN	Connect the MIDI device that controls the MKS-70, such as MIDI Keyboard, MIDI Guitar Controller, computer, etc.
OUT	Through this connector, the Exclusive or Program Change message is sent out from the MKS-70.
THRU	Through this connector, the exact copy of the message fed into the MIDI IN is sent out.

● **Output Jacks**

Jack(s) used	Output
e	Monaural Output of the mixture of Tone A and Tone B
a d	Stereo Output of the mixture of Tone A and Tone B
b c	b: Monaural Output of Tone A c: Monaural Output of Tone B
a b	Stereo Output of Tone A
c d	Stereo Output of Tone B
a b c d	a b: Stereo Output of Tone A c d: Stereo Output of Tone B

* When the Key Mode is set to WHOLE (see page 14), connecting an amplifier to b and c will cause unequal distribution of the sounds, but this is not because of the trouble of the unit.

● **Output Level Switch**

This switch serves to select the output level depending on the type of the amplifier connected to the Mix Output Jack.

* This switch has no effect on the Parallel Output Jack.

1 OUTLINE OF THE MKS-70

To make the best use of the MKS-70's functions, please read the following explanation, before going to "OPERATION".

The MKS-70 is a MIDI sound module which can be played by the MIDI messages sent from the external device on the set MIDI Channel.

■ MKS-70's Sound Structure

The MKS-70 has two sections: **Block A** and **Block B**. Each Block consists of six **Sound Modules**, and each **Sound Module** contains two DCO's, a VCF, a VCA and two Envelope Generators. So, you may consider each Block as a six voice polyphonic synthesizer.

Two different MIDI receive channels (**Channel A** and **Channel B**) are assigned to the corresponding Blocks.

■ MKS-70's Memory Structure

● Tone

The MKS-70 can retain 100 different sounds (**Tones**) from number 1 to 100 in each internal memory and memory cartridge. 50 Tones can be rewritten, other 50 Tones are non-volatile.

A Tone is assigned to each Block, and a Tone consists of various **Parameters**. Using the optional programmer PG-800, the parameters can be more easily edited.

● Patch



The MKS-70 can retain up to 64 different combinations of a Tone or Tones and various performance controlling functions in each internal memory and memory cartridge. This combination is called a **Patch**. In other words, a **Patch** consists of a Tone or a pair of Tones and performance controlling functions which we call **Factors** in this manual. Normally, to change sounds during live performance, select a different Patch.

● MIDI

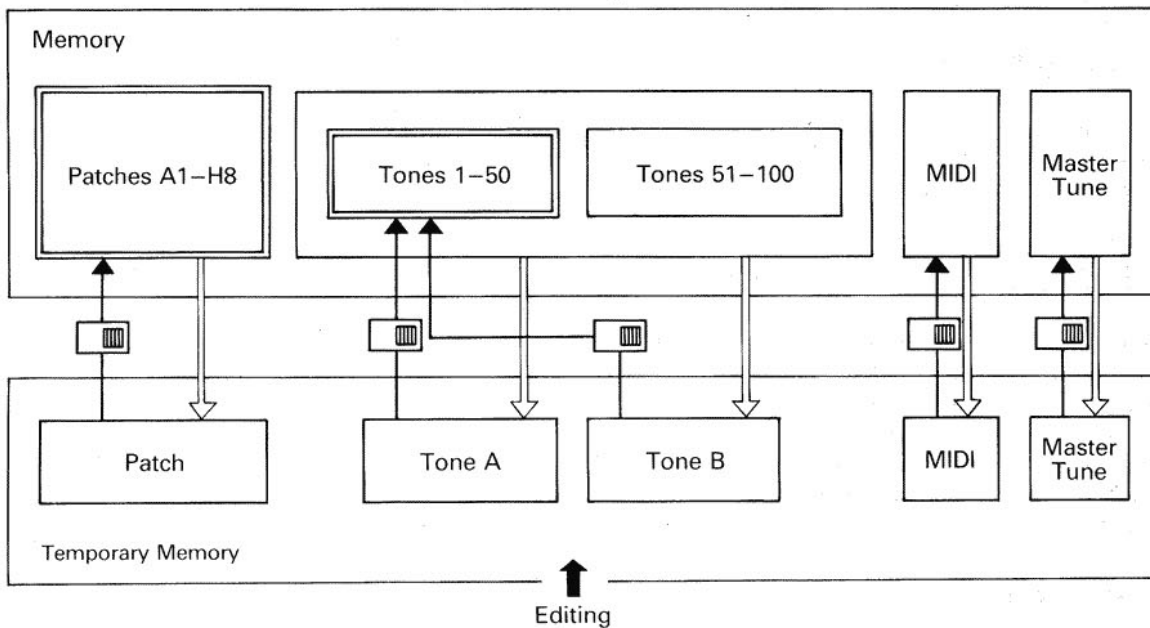

The MKS-70 features several **MIDI Functions** which determine how the unit is played by the external controller. The setting of MIDI Functions can be stored in the internal memory or the memory cartridge.

MKS-70 Memory Structure



 : Select INTERNAL or CARTRIDGE by using 

 : Protect Switch OFF

 Calling
 Writing

2 OPERATION

1. MKS-70's Three Operation Modes

The MKS-70 has three operation modes: Playing Mode, Editing Mode and Writing Mode.

- **Playing Mode**

In the Playing mode, you can call a Patch you like and play it. This mode also allows to perform Quick Editing. (e.g. Tone selection, Key Mode selection, etc.)

- **Editing Mode**

The Editing mode allows to edit Patch Factors, Tone Parameters and MIDI Functions. In the Editing mode, you can name the Patch and Tone. Editing does not automatically rewrite the previous data unless taking an appropriate writing procedure. That is, the edited data will be erased when the unit is turned off.

- **Writing Mode**

The Writing mode allows to write the edited data into the internal memory or onto the memory cartridge.

2. Playing Mode

- ▶ Turn on the MKS-70, then MIDI transmit unit, then finally the amplifier.

When the MKS-70 is turned on, the Display responds with:

```
***** ROLAND MKS-70 *****
```

- * While the above indication is shown, the muting circuit is working, therefore no sound is obtained.

In several seconds later, the Display shows the basic Playing mode indication:

```
I-A1 ELECTRIC PIANO 1 39 83.
```

a
b
c
d
e

The indication represents:

a) Voice Memory Area

- I: MKS-70's internal memory
- C: Memory Cartridge

b) Patch Number

A Patch is shown in the combination of an alphabet of A to H and a number of 1 to 8 such as A3, H1, etc.

c) Patch Name

d) Tone Number of Tone B

e) Tone Number of Tone A

This is the indication of a usual playing mode.

a. Setting MIDI Channel

The MKS-70 requires to set different MIDI channels (Channel A and B) for Tone A and Tone B.

How to set MIDI Channel

How to set MIDI channels on the MKS-70 differs depending on the type of MIDI device connected.

The following is an example for setting MIDI channel.

- **Controller featuring single MIDI Transmit Channel**
(e.g. Alpha JUNO, JX-8P, Roland Piano)

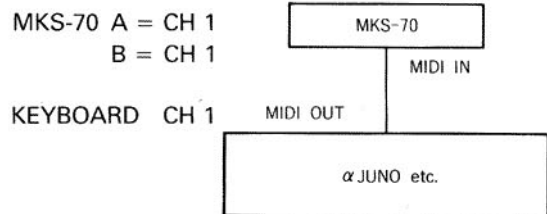

- **Controller featuring more than one MIDI Transmit Channel**
(e.g. MKB-1000·300·200, JX-10)

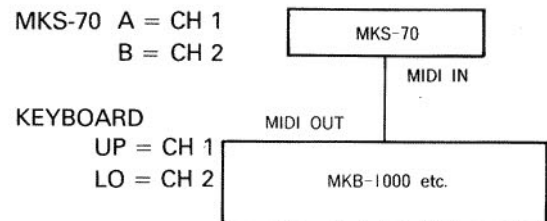

- **Controller featuring MIDI Mono Mode**
(GUITAR + GK-1 + GM-70)

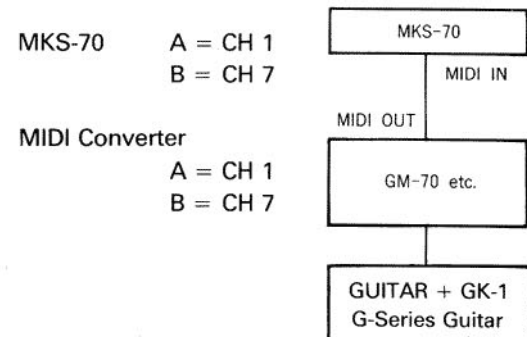

Setting MIDI Channel A

- ① Push the MIDI Button.

The indicator on the MIDI Button lights up and the unit is in the MIDI Function editing mode.

- ② Push 1 then 2 of the Patch Memory/Number Buttons **7**.

"21" appears at the lined space of the Display. This is the MIDI Function number. The number shown at the far-right of Display is the MIDI Channel number.

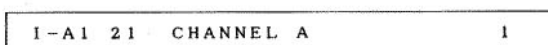

- ③ Select the MIDI channel you want with the Alpha Dial.

Setting MIDI Channel B:

- ④ Push 3 then 1 of the Patch Memory/Number Buttons **7**.



- ⑤ Using the Alpha Dial, select the MIDI channel you want.

- ▶ The MIDI channel you set will be erased when the unit is turned off. If you wish to retain the channel setting, write it as explained on page 43 "Writing MIDI Functions".

When the MIDI signal is sent on the set channel, the MIDI Message Indicator flashes.

MIDI MESSAGE



Connection with MIDI Guitar Controller (Mono Mode)

The MKS-70 features the Mono Mode that is exclusively useful when used with a guitar controller. In the Mono mode, the MKS-70 receives signal from each string separately to each module. This gives the effect of creating the realistic guitar sound.

When the MKS-70 is set to the Mono mode, or the Mono mode command is received, the Mono Mode Indicator lights up.



When the Mono mode is selected, the channels are assigned to the strings as shown below.

1st string	ch (n)
2nd string	ch (n + 1)
3rd string	ch (n + 2)
4th string	ch (n + 3)
5th string	ch (n + 4)
6th string	ch (n + 5)

* n represents the MIDI channel number currently selected.

When "A WHOLE" Key Mode is selected, or "B WHOLE" Patch is in use, the channels up to n + 11 are available.

The strings of the channel number higher than 17 ch will be ignored.

- ▶ **When the MKS-70 receives the command to select a certain channel number, it has the priority.**

The set of channel numbers assigned to the six strings in the Channel A is called **Channel Group A**, and that of the Channel B is **Channel Group B**.

How to turn to the Mono Mode

- ① Push the MIDI Button.
- ② Push 1 of the Patch Memory/Number Buttons twice ⑦.
- ③ Rotate the Alpha Dial until the following indication appears in the Display.

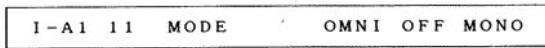

The MIDI Mono Mode Indicator lights up.

*** The MKS-70's Mono mode does not allow to set a different sound for each note separately, because each channel is not perfectly independent.**

- ▶ When you have selected the channel and the mode you want, push the MIDI Button to return to the playing mode.

b. Patch Selection

During live performance, you may usually set the MKS-70 to the Playing mode and select a patch in the internal memory or in the cartridge.

How to change Patches

- ① By pushing the CART Button, select whether to use the Patch in the internal memory or the memory cartridge.

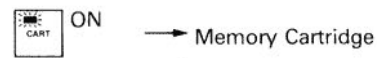
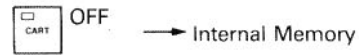

Here, the previous Patch still remains.

- ② Assign the Patch you like by pushing the appropriate Patch Memory Buttons.

Now, the new patch is called ready to be used.

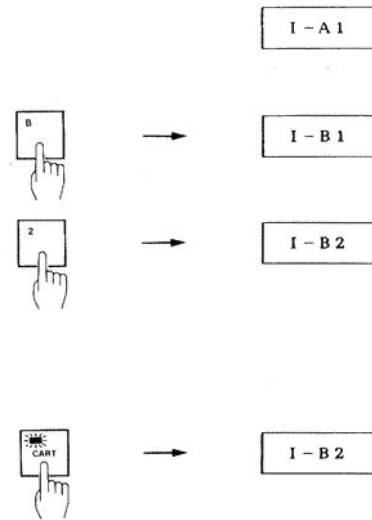

As the Display shows, the cartridge memory is not selected yet.



c. Key Mode

1) MKS-70's Six Key Modes

The **Key Mode** decides how to assign the two sound blocks.

- **Dual (DUAL)**

The Dual Mode turns the MKS-70 to the six voice polyphonic that allows both the Tone A and Tone B to sound simultaneously. Each Tone can be separately taken through the Parallel Outputs giving the effect as if two sets of synthesizers are simultaneously played.

- **Touch Voice Select (T. VOICE)**

In this mode, either the Tone A or Tone B will sound depending how you play the keyboard. That is, when you play the keyboard harder than the set level (threshold level), the Tone A is selected and when you play softer than the set level, the Tone B sounds. In other words, when the level is set higher, stronger key pressure is needed to obtain Tone A. Naturally, within the set level, dynamics can be obtained.

The threshold level is where the Upper Split Point (on page 30) is set. So, to change the threshold level, move the Upper Split Point.

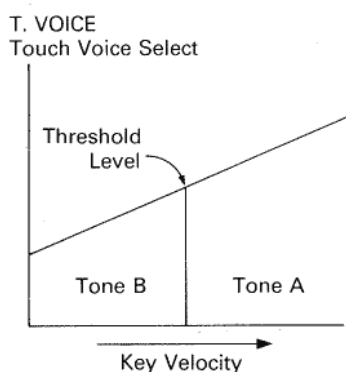

- **Corss Fade (X-FADE)**

This mode is a kind of Dual. As shown in the picture, the volume of the Tone A decreases by stronger key touch, and the volume of the Tone B decreases by weaker key touch. This mode, therefore, can be effectively used to change the volume balance of the Tones by changing the playing manners. You cannot obtain this effect if using the Tones whose dynamics are all turned off.

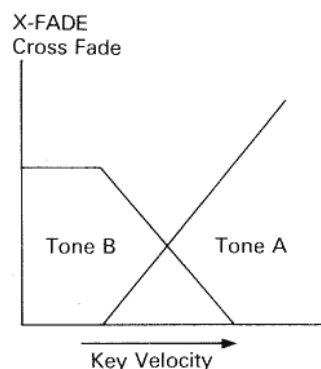

- **A whole (A WHOLE)**

In the A Whole mode, both of the two sound blocks will have the Tone A in 12 voice polyphonic.

- **B Whole (B WHOLE)**

In the B Whole mode, both of the two sound blocks will have the Tone B in 12 voice polyphonic.

● **Split (SPLIT)**

There are two kinds of Split modes depending on whether the Channels A and B are set to the same MIDI channel number or to different numbers.

SPLIT I: The Channels A and B are set to the same MIDI channel number.

The MKS-70's Split system allows to set the lowest Key Number with "Upper Split Point" (see page 30 "Split Point"), and the highest Key Number with "Lower Split Point". The Tone A will sound when the signal higher than the lowest Key Number you set is received, and the Tone B will sound when the signal lower than the highest Key Number set is received.

Split I mode is effective when the MKS-70 is used with a MIDI controller that features a single MIDI channel. Here, set the MIDI channel of the MKS-70's Channels A and B to the same number as the controller.

SPLIT II: The Channels A and B are set to different MIDI channel numbers.

The key information sent on the channel A will sound the Tone A, and that sent on the channel B will sound the Tone B.

The Split II mode is effective when the MKS-70 is used with the MIDI controller that features more than one channel number.

Example)

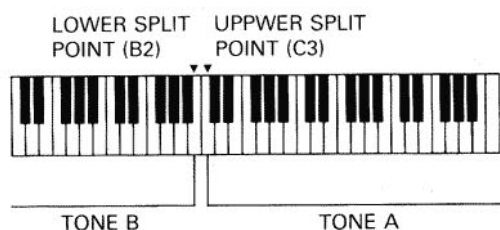

Example)

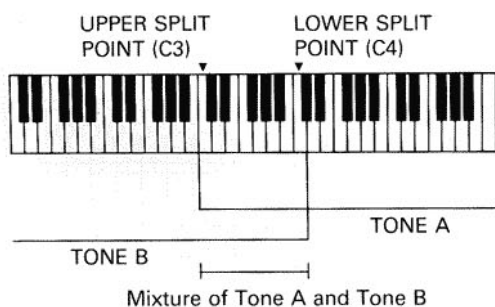

2) Key Mode and the Receive MIDI Channel

Table-1

KEY MODE	TONE	RECEIVE CHANNEL	
		MIDI POLY MODE	MIDI MONO MODE
DUAL T. VOICE X-FADE	TONE A TONE B	CHANNEL A	CHANNEL GROUP A
		(CHANNEL B)*	(CHANNEL B)*
A WHOLE	TONE A	CHANNEL A	CHANNEL GROUP A
B WHOLE	TONE B	CHANNEL B	CHANNEL GROUP B
SPLIT	I TONE A TONE B	CHANNEL A CHANNEL GROUP B	CHANNEL GROUP A CHANNEL GROUP B
		CHANNEL A	CHANNEL GROUP A
	II TONE B	CHANNEL B	CHANNEL GROUP B

*On the Channel B, only Program Change messages are received.

<DUAL> <T. VOICE> <X-FADE>
POLY MODE

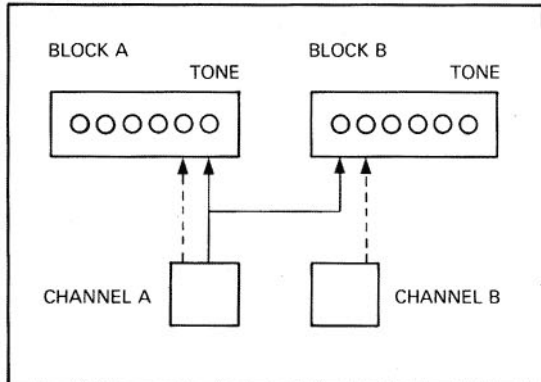

<A WHOLE>
POLY MODE

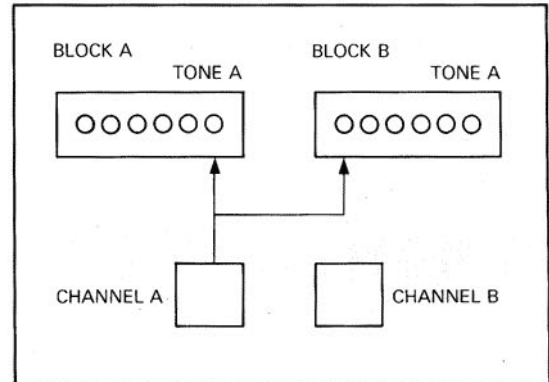

MONO MODE

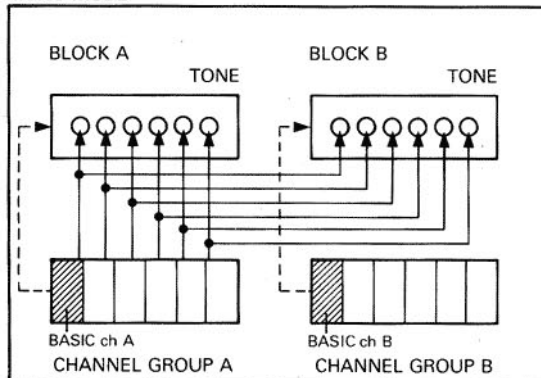

MONO MODE

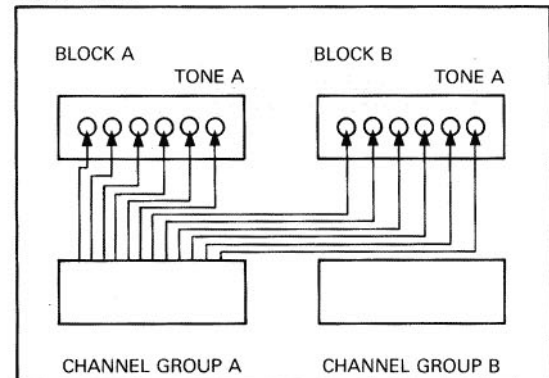

*The dotted lines represent Program Change Message

<B WHOLE>
POLY MODE

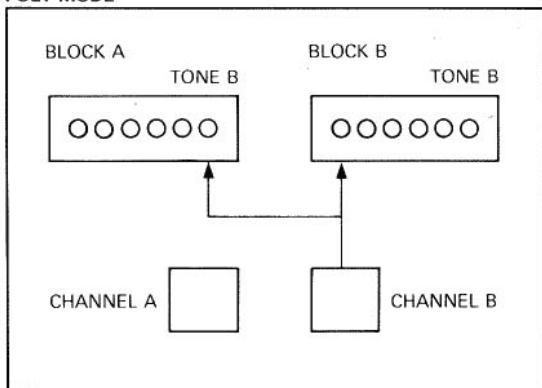

<POLY MODE>
POLY MODE

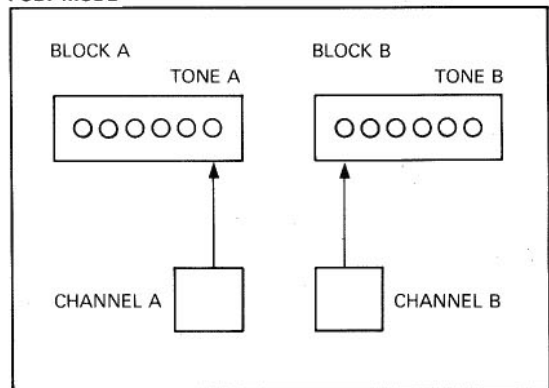

MONO MODE

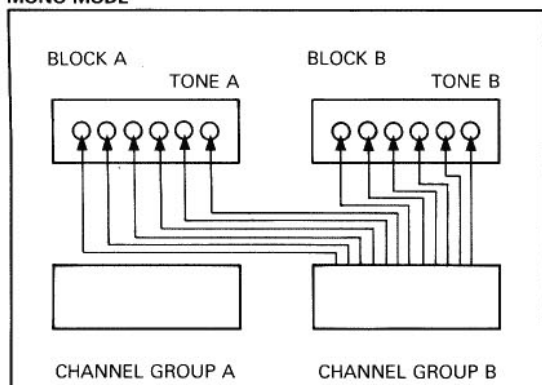

MONO MODE

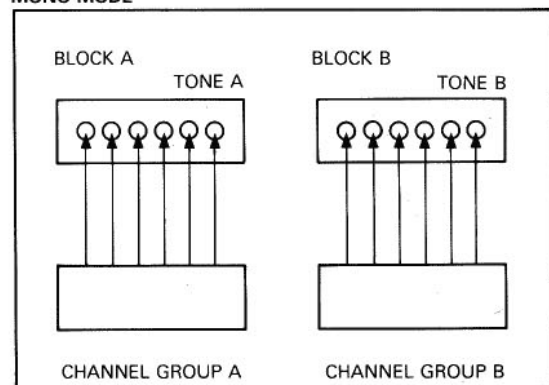

d. Quick Edit

The following three Factors can be edited even during live performance just by touching the relevant buttons without turning to the Edit mode. This is called **Quick Edit** mode.

- Key Mode Selection
- Tone Number Selection
- Chase Playing On/Off

- ▶ The edited data, however, does not remain in memory unless you take the appropriate writing procedure explained on page 41.

1) Key Mode Selection

- ① Push the SHIFT Button.

The corresponding indicator lights up, and the Patch Memory Buttons A to F now work for selecting a Key Mode.



- ② Push the relevant button to select the Key Mode you want.

The buttons correspond to the Key Modes as follows:

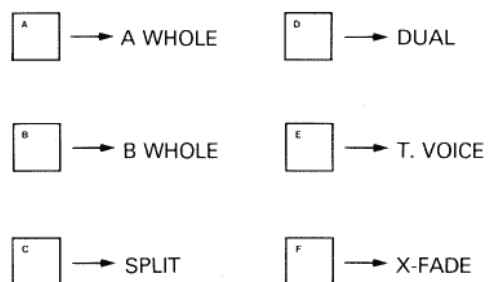

The Display shows the selected Key Mode.



In about two seconds, the Display returns to the usual Playing mode indication.

- ③ Push the SHIFT Button.

The indicator goes out.

2) Tone Number Selection

Make sure that the MKS-70 is in the Playing mode.

- ① Push ► or ◀ button to select the Tone A or B.

The digit moves to the lower left to the Tone Number which is to be changed.

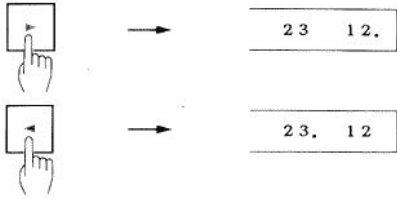

- ② Push the SHIFT Button.

The indicator on the Shift Button lights up and the Patch memory Buttons 0 to 9 now work for selecting a Tone Number.



- ③ By pushing the relevant buttons, select the Tone Number you want.

- ④ Push the ENTER Button.



- ⑤ Push the SHIFT Button.

The indicator goes out.

3) Chase Playing

The Chase Playing function makes it possible to play one of the two Tones slightly later than the other Tone or repeat playing.

- Pushing the Chase Button turns the Chase Playing function on or off.

When the Patch Factor "54 CHASE PLAY" (see page 54) of the selected Patch is set to OFF, pushing the Chase Play Button will turn the Chase Playing function on (the indicator lights up). On the contrary, when it is set to ON, pushing the same button will turn the effect off (the indicator goes out).



- How to set the sequence of the Tones or the delay time of the two Tones is explained on page 34 "Patch Editing".

3. Editing Mode

The Editing mode allows you to recall and edit the data written in the internal memory or on the memory cartridge.

Pushing the EDIT Button (PATCH, TONE or MIDI) will light up the corresponding indicator, and the Display shows the name of the Patch Factor, Tone Parameter or MIDI Function and the value. This is the Edit mode.

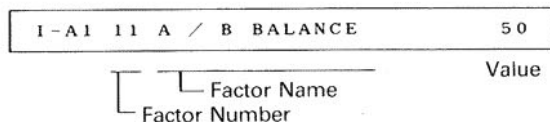
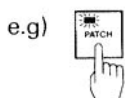
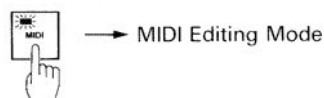
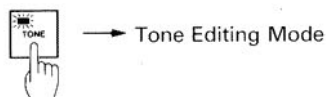
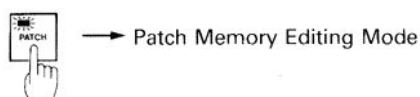

Pushing the same Edit Button will return the unit to the Playing mode.

- ▶ Edited data does not remain in memory unless taking the appropriate Writing procedure explain on page 41. The edited Patch or Tone is erased when a different Patch or Tone, and the MIDI Factor is erased when the unit is switched off.

a. Tone Editing

A Tone consists of various Tone Parameters, so, a Tone can be edited by changing the values or settings of the parameters.

There are two methods of Tone Editing:

- (1) Call the Patch to be edited and while actually listening to the sound, edit the Tone A and B of which the Patch consists.

You can select the Tone A or B by using the ► and ◀ buttons.







- (2) Call a Tone A or B and edit a single Tone while listening to the sound.



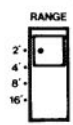

Call the Tone to be edited in the Key Mode of either A Whole or B Whole. Even in other mode, you can edit a Tone by turning down the volume of the other Tone (See page 29).

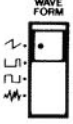
PARAMETER TABLE

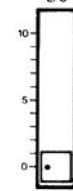
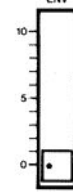
DCO (Digitally Controlled Oscillator)

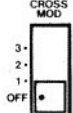
DCO is the digitally controlled oscillator that controls the pitch and generates the waveforms that are the sound source of the synthesizers. Owing to its digital control system, this offers superior pitch stability compared to the VCO (Voltage Controlled Oscillator). The MKS-70 has 2 DCO's.

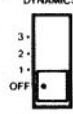
Number	Parameter Display	Data Value	Function	Programmer
11	DCO1 RANG	2'	This is to change the pitch range of the DCO in exact one octave steps from 2' to 16' (2', 4', 8', 16'). 8' is standard.	
	DCO-1 Range	4'		
21	DCO2 RANG	8'		
	DCO-2 Range	16'		
12	DCO1 WF	SAWT	This is to choose the output waveform of the DCO. SAWT:  (Saw Tooth) PULS:  (Pulse Wave) SQUR:  (Square Wave) NOIS:  (Noise)	
	DCO-1 Waveform	PULS		
22	DCO2 WF	SQUR		
	DCO-2 Waveform	NOIS		
13	DCO1 TUNE	+ 12	This changes the frequency (pitch) of the DCO, in semi-tone steps. •Variable Range: ±12 (±1 Octave)	
	DCO-1 Tune	00		
24	DCO2 TUNE	00		
	DCO-2 Tune	- 12		
14	DCO1 LFO	99	When the LFO output is modulating the DCO, this parameter is used to adjust the depth of the modulation. For vibrato effect, select "SINE" with the LFO Waveform.	
	DCO-1 LFO Depth			
26	DCO2 LFO			
	DCO-2 LFO Depth			
15	DCO1 ENV	00	When the ENV output is modulating the DCO, this parameter is used to adjust the depth of the modulation.	
	DCO-1 Envelope Depth			
27	DCO2 ENV			
	DCO-2 Envelope Depth			

Parameter		Data Value	Function	Programmer
Number	Display			
23	DCO XMOD	XMOD	<ul style="list-style-type: none"> • X MOD: DCO-1 and DCO-2 affect each other, pitch, harmonic contents and waveform. • SNC 2: Both SYNC 1 and X MOD work together. • SNC 1: The pitch is determined by DCO-1, and the harmonic contents by DCO-2. The waveform is determined by the DCO-2's synchronization to DCO-1. • OFF: Each DCO-1 and DCO-2 can have different pitch and waveform. 	
Cross Modulation		SNC2		
		SNC1		
		OFF		
25	DCO2 FTUN	+50	The frequency (pitch) of the DCO-2 can be adjusted with this parameter. <ul style="list-style-type: none"> • Variable range... ± 50 cent 	
DCO-2 Fine Tune		-50		
31	DCO DYNA	3	When the DCO's pitch is controlled by the ENV, and the amount of the ENV is controlled by Dynamics (Key Touch), this parameter adjusts the sensitivity of Key Touch. (Note 1)	
DCO Dynamics Range		2		
		1		
		OFF		
32	DCO MODE	U-1	This selects the polarity of the Envelope curve. Normally, \wedge is used. In \vee mode, ADSR pattern will be all inverted. U-1 : ENV 1 \wedge U-1 : ENV 1 \vee U-2 : ENV 2 \wedge U-2 : ENV 2 \vee	
DCO Envelope Mode		U-1		
		U-2		
		U-2		

Note 1

Depending on the position of the Dynamics Range Selector, the tone color alteration differs as shown below.

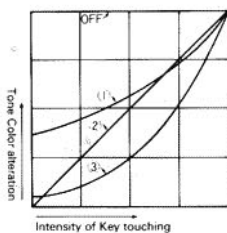

Note 2



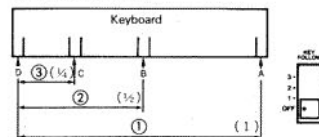





Envelope Key Follow



- OFF: All Keys have the same Envelope time.
- ①: The highest Key A has the ENV time exactly half length of the lowest Key D's.
 - ②: The Key B has the ENV time exactly half length of the lowest Key D's.
 - ③: The Key C has the ENV time exactly half length of the lowest Key D's.



MIXER

This is where the volume balance of the DCO-1 and DCO-2 is controlled.

Parameter		Data Value	Function	Programmer	
Number	Display				
41	MIX DCO1	99	This adjusts the level of DCO-1.		
	DCO-1 Level				
42	MIX DCO2)	This adjusts the level of DCO-2.		
	DCO-2 Level				
43	MIX ENV	00	When ENV controls the DCO-2's level, this sets the amount of ENV signal.		
	DCO-2 Envelope Depth				
44	MIX DYNA	3 2 1 OFF	When the DCO-2's level is controlled by ENV Depth and then by Dynamics, this sets the sensitivity of the Key Touch. [NOTE 1]		
	DCO-2 Dynamics Range				
45	MIX MODE	0-1	Normally,  is used, and in  mode, ADSR pattern will be inverted.		
	DCO-2 Envelope Mode	0-1			0-1 : ENV 1 
		0-2			0-1 : ENV 1 
		0-2			0-2 : ENV 2 

VCF (Voltage Controlled Filter)

The output signal goes to the Mixer then to the VCF to be filtered. Each VCF lets lower frequency harmonics pass and cuts off the higher ones. In other words, it is a usual low pass filter. By controlling the cutoff point and resonance, the waveform changes, thereby the tone color alters.



Parameter		Data Value	Function	Programmer
Number	Display			
51	HPF FREQ	3 2 1 0	The HPF (High-Pass Filter) is a filter that passes higher frequency harmonics and cuts off the lower ones. As you increase the value, cutoff point goes up, lower frequency harmonics being cut off.	
	High-pass Filter Cutoff Frequency			
52	VCF FREQ	99	This is for changing the cutoff point of the VCF. As you decrease the value, cutoff frequency will come down, and the waveform gradually becomes approximation of a sine wave, then the sound will fade out.	
	Cutoff Frequency) 00		

Parameter		Data Value	Function	Programmer
Number	Display			
53	VCF RES	99) 00	<p>This emphasizes the cutoff point. As you increase the value, the created sound will become more unusual, more electronic in nature.</p> <p>This controls the cutoff point by the waveform selected at the LFO section. Increasing the value deepens the modulation.</p> <p>This controls the cutoff point of the VCF in each note with the ENV curve set in the ENV section. As you increase the value, tone color within one note changes more drastically.</p> <p>This can shift the cutoff point by key position (pitch). At 100%, it prevents any inconsistency in the harmonic contents caused by pitch alteration.</p> <p>Parameter value 83 (=Programmer's Knob "8")= 100%</p>	
	Resonance			
54	VCF LFO			
	LFO Depth			
55	VCF ENV	00	<p>This can shift the cutoff point by key position (pitch). At 100%, it prevents any inconsistency in the harmonic contents caused by pitch alteration.</p> <p>Parameter value 83 (=Programmer's Knob "8")= 100%</p>	
	Envelope Depth			
56	VCF KEY			
	Key Follow			
57	VCF DYNA	3	<p>When the VCF is controlled by ENV and Key Touch (Dynamics), this parameter determines the sensitivity of the Key Touch. (Note 1)</p>	
	Dynamics Range	2		
		1		
		OFF		
58	VCF MODE	0-1	<p>This is to select the polarity of the Envelope curve that controls VCF. Usually \wedge may be used. In \vee mode, ADSR pattern will be inverted.</p> <p>0-1: ENV1 \wedge 0-1: ENV1 \vee 0-2: ENV2 \wedge 0-2: ENV2 \vee</p>	
	Envelope Mode	0-1		
		0-2		
		0-2		

VCA (Voltage Controlled Amplifier)/
Chorus

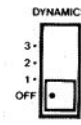
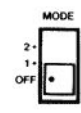

After filtered in the VCF, the signal is fed to the VCA where the volume (amplitude) of the sound is controlled.

Parameter		Data Value	Function	Programmer
Number	Display			
61	VCA LEVEL	99	<p>This is to adjust the volume level, and can be effectively used in the writing mode. If it is set too high, sound may be distorted.</p>	
	VCA Level)		
		00		

Parameter		Data Value	Function	Programmer
Number	Display			
62	VCA MODE	ENV2	This is to select whether to control the VCA by the signal from the ENV-2 () or by the Gate signal ().	
	VCA Mode	GATE		
63	VCA DYNA	3	This parameter determines the sensitivity of the Key Touch (Dynamics effect). (Note 1)	
	VCA Dynamics Range	2		
		1		
		OFF		
64	CHORUS	2	2: Rich Chorus effect is obtained. 1: Expansive Chorus effect is obtained. OFF: Chorus is off	
	Chorus Mode	1		
		OFF		

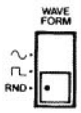
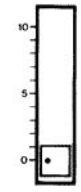

LFO (Low Frequency Oscillator)

This oscillator generates extremely low frequency, so produces a vibrato or growl effect by controlling the DCO or VCF.

Parameter		Data Value	Function	Programmer
Number	Display			
71	LFO WF	SINE	This is for selecting the LFO output waveform. SINE:  (Sine Wave) SQR:  (Square Wave) RAND: Random	
	LFO Waveform	SQR		
		RAND		
72	LFO DELAY	99	This sets the time needed for the modulation by the LFO to start.	
	Delay Time	00		
73	LFO RATE	99	This sets the rate (frequency) of the LFO.	
	Rate	00		

ENV (Envelope Generator)

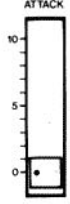
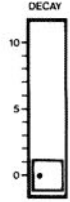
This generates the control voltage (Envelope) which controls the DCO, VCF and VCA, therefore, alters the pitch, tone color and volume in each note.

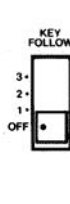
Parameter		Data Value	Function	Programmer
Number	Display			
81	ENV 1 ATT		This determines the time required for the voltage to reach its maximum from the moment the key is played.	
	ENV-1 Attack Time			
91	ENV 2 ATT			
	ENV-2 Attack Time			
82	ENV 1 DECAY	99	This determines the time required for the voltage to drop from the maximum to the sustain level.	
	ENV-1 Decay Time			
92	ENV 2 DECAY)		
	ENV-2 Decay Time			
83	ENV 1 SUS	00	This sets the sustain level to which the voltage falls at the end of the decay time. Therefore, at its maximum setting, Decay Time Knob has no effect.	
	ENV-1 Sustain Level			
93	ENV 2 SUS			
	ENV-2 Sustain Level			
84	ENV 1 REL		This sets the time needed for the voltage to reach zero from the moment the key is released.	
	ENV-1 Release Time			
94	ENV 2 REL			
	ENV-2 Release Time			
85	ENV 1 KEY	3	This changes the time required for an ENV curve to complete its curve (= ENV time). At OFF, all the pitches have the same ENV time. As the value is increased, higher keys have shorter ENV time. (Note 2)	
	ENV-1 Key Follow	2		
95	ENV 2 KEY	1		
	ENV-2 Key Follow	OFF		

Tone editing can be done quicker and easier by using the optional programmer PG-800, but even without it, it can be done by calling each parameter by assigning the relevant parameter number and changing the value.

1) Editing without using the programmer

- ① Push the TONE of the Edit Buttons.
- ② By pushing the relevant buttons of the Patch Memory/Number Buttons ⑦, assign the number of the parameter to be edited.

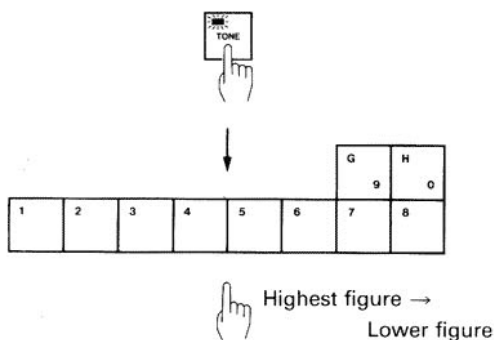

- ③ While actually listening to the sound, change the value of the parameter.



- ④ To continue to edit other parameters, repeat the steps ② and ③ as many times.
- ▶ **To call parameter, you can use the Alpha Dial instead of the Number Buttons ⑦. Push the TONE then the PARAM Buttons, and rotate the Alpha Dial until the parameter you want is shown in the Display. Then push the VALUE of the Edit Buttons and change the value with the Alpha Dial.**
- ⑤ When editing is completed, push the TONE Button to return to the Playing mode.

2) Editing with the programmer PG-800

Editing will be much easier by using the programmer PG-800.

- ① As shown below, set up the programmer and the MKS-70 using the 6P DIN cable supplied with the PG-800.

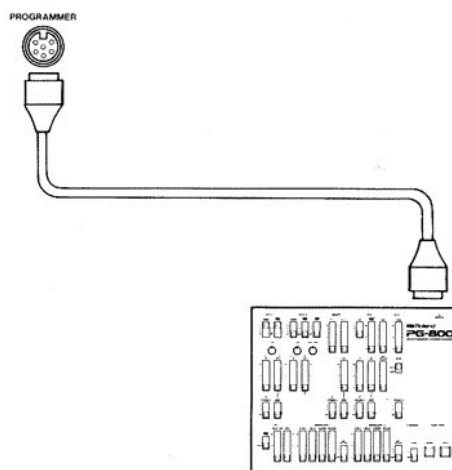

- ② By moving the control knobs and switches on the programmer's panel, edit the Tone to your taste.

Here, you can turn the MKS-70 to the Editing mode by pushing the TONE Button, so that the Display shows the name and the value of the parameter currently in use.

When the switch or button on the programmer is even slightly moved, the value of the relevant parameter is changed. In other words, the value of the parameter remains intact if the relevant switch or the button is not moved at all.

The MKS-70 features Manual mode in which the whole panel setting on the programmer decides the Tone. That is, existing Tone written in memory has nothing to do with your sound synthesis. To turn the MKS-70 to the Manual mode, simply push the Manual Button on the programmer.

* The programmer does not work when the MKS-70 is set to the Writing mode or Bulk Damp mode (see page 45).

- ▶ If the Write Button on the programmer is accidentally pushed during Tone editing, the edited Tone will automatically rewrite the Tone previously written. To avoid this, be sure to set the Protect Switch on the MKS-70 to the PROTECT position (see page 40).

3) Recalling a Tone

“Recalling a Tone” is the function which can be used during Tone editing. While you are editing a Tone, you may want to call the original Tone which is intact, to probably compare it with the one you have edited.

PROCEDURE

- ① Push the ▶ button if editing the Tone A and push ◀ button if editing the Tone B, and the original Tone will be called.

***** RECALL *****

- ② Push the same button pushed in the step ① to return to the edited Tone.

* Naturally, the recalled Tone cannot be edited.

b. Patch Editing

1) Patch Factors

• Tone

I-A1 31 A TONE NUMBER ***

41 B TONE NUMBER ***

1-100

These Factors set the Tone Numbers of Tones A and B.

* The Tone Factor includes the Tone Number, but it does not include the contents (parameters) of the Tone.

11 A/B BALANCE **

00-99

This Factor determines the volume balance of the Tone A and the Tone B. When the value is set around 50, the volumes of the both Tones are the highest, and as the value increases, the Tone B's volume decreases, the Tone A's volume remaining the highest. That is, when the value in the Display is 99, only the Tone A will be heard. When the value is smaller than 50, the opposite effect will be obtained.

32 A CHROMATIC SHIFT ***

42 B CHROMATIC SHIFT ***

-24-00-+24

These Factors can shift the pitches of the Tone A and Tone B separately in semi-tone steps in the range of 4 octaves; 2 octaves upper and lower. If the key exceeding A0 to C8 is played, it will be substituted by the highest or the lowest octave within the range.

• Key Mode

17	KEY MODE	*****
----	----------	-------

 DUAL
 T-VOICE
 X-FADE
 A WHOLE
 B WHOLE
 SPLIT

► See page 14.

12	DUAL DETUNE	***
----	-------------	-----

-50-00-+50

When the Key Mode is set to Dual, this Factor can detune the Tone B from the Tone A. At "+" value, the Tone B's pitch is raised and at "-" value, it is lowered.

• Split Point

13	UPPER SPLIT POINT	***
----	-------------------	-----

14	LOWER SPLIT POINT	***
----	-------------------	-----

A0-C8

These Factors are the Upper Split Point and the Lower Split Point in the Split I mode (see page 15).

The Upper Split Point sets the lowest key number, and the Lower Split Point sets the highest key number. The signal higher than the Upper Split Point will play the Tone A and the signal lower than the Lower Split Point will play the Tone B. The value is shown with the octave and the note name; the lowest note is A0 and the highest note is C8 and the middle C is C4. ("+" indication represents #.)

► The Split Point can also be set by sending the Key On message from the connected MIDI controller, as well as using the Alpha Dial on the MKS-70. Call the relevant Factor, then play the appropriate key on the keyboard while holding down the C button of the Patch Memory Buttons 7.

• Key Assign

The MKS-70 has six modules for the Tone A and another six for the Tone B, altogether twelve modules. The following Factors determine how to assign these modules to the keys played.

In the MIDI Mono mode, these Factors are irrelevant.

33	A KEY ASSIGN	*****
43	B KEY ASSIGN	*****

POLY 1
POLY 2
UNISON 1
UNISON 2
MONO 1
MONO 2

POLY 1

This mode turns the MKS-70 to six voice polyphonic, assigning one module to each key pressed. This mode is ideal for the sound whose envelope curve is similar to the piano's or guitar's, therefore should be selected for usual performance.

POLY 2

This mode is very similar to Poly 1, assigning only one module to each key played. However, the same module as assigned to the key previously played is assigned to the note played later. So, this mode is ideal for the performance with portamento effect.

UNISON 1

In this mode, two sound modules are assigned to each key, therefore the created sound is richer than Poly mode. That is, each of the Tones A and B becomes three voice polyphonic.

UNISON 2

This is similar to the Unison 1 mode, but one of the two modules is one octave lower than the other, therefore creating even fatter sound than Unison 1.

MONO 1

This mode turns each of the Tones A and B to a single voice synthesizer that assigns one module to each key. When more than one key is played at a time, the last key has priority.

MONO 2

This mode turns each of the Tones A and B to the monophonic synthesizer that assigns all six modules to one key pressed. When more than one key is played at a time, the last key has priority.

Key Modes and Key Assign Modes

<DUAL>

→ Each of Tone A and Tone B is played in the individual Key Assign mode.

<TOUCH VOICE SELECT>

→ The Key Assign set with "43 B KEY ASSIGN" is ignored, and both of Tones A and B are played in the Key Assign mode set with "33 A KEY ASSIGN".

<CROSS FADE>

→ The Key Assign set with "43 B KEY ASSIGN" is ignored, and both of Tones A and B are played in the Key Assign mode set with "33 A KEY ASSIGN".

<A WHOLE>

→ The Key Assign set with "33 A KEY ASSIGN" is ignored, and both of Tones A and B are played in the Poly 1 Key Assign mode when the "37 A PORTAMENTO" is set to OFF, and played in Poly 2 mode when the Portamento is ON.

<B WHOLE>

→ The Key Assign set with "43 B KEY ASSIGN" is ignored, and both Tones are played in Poly 1 mode when "47 B PORTAMENTO" is OFF, and played in Poly 2 when the Portamento is ON.

<SPLIT>

→ Each of Tones A and B is played in the individual Key Assign.

34	A UNISON DETUNE	***
----	-----------------	-----

44	B UNISON DETUNE	***
----	-----------------	-----

-50-00-+50

When the Key Assign is UNISON 1 or UNISON 2, this Factor can detune one of the two modules. "+" raises the pitch and "-" lowers.

● Total Volume

18	TOTAL VOLUME	**
----	--------------	----

00-99

This Factor allows to set an individual volume of each Patch. This is useful to reduce the volume difference between the Patches.

● Aftertouch

Aftertouch is the change caused by playing the key harder after a usual manner. The MSK-70 features three Aftertouch effects, vibrato, brilliance and volume. The sensitivity of each Aftertouch can be set here. All the three Aftertouch effects can be obtained at a time, if you like.

21	AFTER TOUCH VIB	**
----	-----------------	----

00-99

Aftertouch causes the vibrato effect. At 00, no effect is obtained, and increasing the value deepens the effect.

22	AFTER TOUCH BRI	**
----	-----------------	----

00-99

Aftertouch causes the brilliance effect. At 00, no effect is obtained, and increasing the value deepens the effect.

23	AFTER TOUCH VOL	**
----	-----------------	----

00-99

Aftertouch causes volume alteration. At 00, no effect is obtained, and increasing the value deepens the effect.

● **Hold**

35	A	HOLD	***
----	---	------	-----

45	B	HOLD	***
----	---	------	-----

ON
OFF

When the MKS-70 is receiving the Hold message from the MIDI IN, these Factors can turn on or off the Hold effect separately for the Tone A and Tone B.

● **Modulation**

36	A	LFO MOD DEPTH	**
----	---	---------------	----

46	B	LFO MOD DEPTH	**
----	---	---------------	----

00-99

When the MKS-70 is receiving Modulation message from the MIDI IN, these Factors can set the depth of the Vibrato effect separately for the Tone A and Tone B. At 00, no effect is obtained, and increasing the value deepens the effect.

● **Portamento**

37	A	PORTAMENTO	***
----	---	------------	-----

47	B	PORTAMENTO	***
----	---	------------	-----

ON
OFF

When the MKS-70 is receiving Portamento message from the MIDI IN, these Factors can turn on or off the Portamento effects separately for the Tone A and Tone B.

15	PORTAMENTO TIME	***
----	-----------------	-----

00-99

This Factor controls the portamento time. Higher value is longer portamento time.

● **Bender**

38	A	BENDER	***
----	---	--------	-----

48	B	BENDER	***
----	---	--------	-----

ON
OFF

When the MKS-70 is receiving Bender message from the MIDI IN, these Factors can turn on or off the Bender functions separately for the Tone A and Tone B.

16 BEND RANGE **

2·3·4·7·12

When the MKS-70 is receiving Bender message from the MIDI IN, this Factor sets the maximum effect of the Bender. The value represents semitone; 2 is the major 2nd 3 is the minor 3rd, 4 is the major 3rd, 7 is the perfect 5th and 12 is one octave. When using the MIDI Guitar System, 12 may be the optimum value. Also, be sure to set the Bend range of the guitar system to the MKS-70's.

* The JX-10 does not work properly with the MKS-70's cartridge whose Bender Range is set to 12. This is because the JX-10's bend range is less than one octave, so change it to any other value.

● Chase Play

Chase Playing function can play one of the two Tones slightly later than the other Tone or repeat playing the sound. This function, therefore is available only in the Dual mode. Depending on the delay time and the Tone in use, the effects created differ: delay like effect, sound-on-sound like effect etc.

51 CHASE PLAY LEVEL **

00-99

This Factor sets the level of the delayed sound (= Tone B).

52 CHASE PLAY MODE ****

A-B-A-
A-B-B-
A-B

This Factor determines in what sequence the delayed sound should be played.

A-B-A-: In this mode, Tone A is played first, then Tone B, Tone A, Tone B, Tone A and so on.

A-B-B-: In this mode, Tone A is played first, then Tone B is played repeatedly.

A-B: In this mode, Tone A is first played, then Tone B. That is all to be played.

53 CHASE PLAY TIME **

01-99

This Factor sets the time between the first (Tone A) and the second (Tone B) sounds. Higher value is the longer time.

54 CHASE PLAY SWITCH ***

ON
OFF

This Factor turns on or off the Chase Playing function. If the Patch of the Chase Play ON is selected here, the Chase Play Button lights up, engaging the Chase Playing function.

Patch Factor Table

11	A/B BALANCE
12	DUAL DETUNE
13	UPPER SPLIT POINT
14	LOWER SPLIT POINT
15	PORTAMENTO TIME
16	BEND RANGE
17	KEY MODE
18	TOTAL VOLUME

21	AFTER TOUCH VIB
22	AFTER TOUCH BRI
23	AFTER TOUCH VOL

31	A TONE NUMBER	41	B TONE NUMBER
32	A CHROMATIC SHIFT	42	B CHROMATIC SHIFT
33	A KEY ASSIGN	43	B KEY ASSIGN
34	A UNISON DETUNE	44	B UNISON DETUNE
35	A HOLD	45	B HOLD
36	A LFO MOD DEPTH	46	B LFO MOD DETPH
37	A PORTAMENTO	47	B PORTAMENTO
38	A BENDER	48	B BENDER

51	CHASE PLAY LEVEL
52	CHASE PLAY MODE
53	CHASE PLAY TIME
54	CHASE PLAY SWITCH

2) How to edit the Patch Factors

- ① Push the PATCH of the Edit Buttons.
- ② Using the Patch Memory/Number Buttons (1 to 8), assign the number of the Factor to be edited.

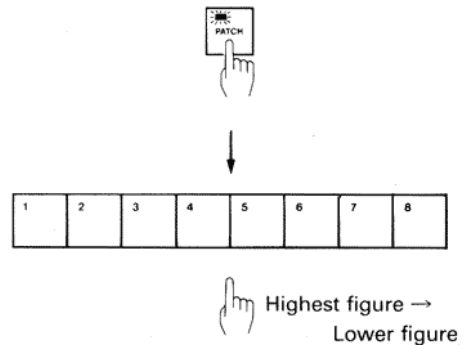

- ③ By rotating the Alpha Dial, change the value of the Factor.



- ④ To continue to edit other Factors, repeat the steps ② and ③ as many times.

► To select the Factor to be edited, you can use the Alpha Dial instead of the Patch Memory/Number Buttons. After pushing PATCH, then the PARAM buttons, rotate the Alpha Dial until the Factor you want appears in the Display, then push the VALUE of the Edit Buttons. Now, change the value by rotating the Alpha Dial.

- ⑤ When the editing is completed, push the PATCH Button to return to the Playing mode.

Now, the Patch Number flashes showing that the Patch is now edited but not yet written into memory.

c. Naming

A Tone can be named using up to 10 letters, and a Patch up to 18 letters.

① Make sure that the MKS-70 is in the Editing mode.

* If naming a Tone, using the ► or ◀ Button, select either the Tone A or B which is to be renamed.

* The MKS-70 is in the Editing mode when the TONE or the PATCH Button is lit.

② Push the NAME Button.

Patch Naming

I - A1 ELECTRIC PIANO 1

Tone Naming

I - A1 TONE - A 39 HARMO 1

③ Move the cursor to the letter to be changed using the ► or ◀ Button, then write the letter with the Alpha Dial or the Patch Memory/ Number Buttons.

The letters available are as follows:

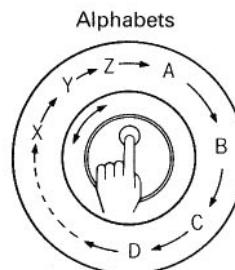

Number and Signs

SPACE	—	*	/	\	.	9	0
A	B	C	D	E	F	G	H
1	2	3	4	5	6	7	8

④ When the naming is completed, take the appropriate writing procedure that varies depending on whether you are writing a Tone or a Patch. (See page 41.)

* If you fail to write the Tone or Patch, the name will be erased.

* Please do not take the naming procedure in the middle of editing, or the edited data will be rewritten.

d. Setting MIDI Functions

1) MIDI Functions

- **Mode**

11	MODE	*****
----	------	-------

OMNI OFF POLY
OMNI OFF MONO

This Function selects one of the MIDI modes; POLY or MONO. Usually select Poly mode, and select Mono mode when the guitar controller is used.

* The MKS-70 is always in the OMNI OFF mode.

- **Channel**

21	CHANNEL A	**
----	-----------	----

31	CHANNEL B	**
----	-----------	----

1-16

This Function selects Channel A or B.

12	CONTROL CHANNEL	**
----	-----------------	----

1-16

MIDI Control Channel number should be set in the following cases:

- (1) To change Patches with the Program Change message
- (2) To transfer the System Exclusive

- **Program Change Receive**

This Factor is to determine how the Program Change messages should work.

13	PATCH PROG CHANGE	***
----	-------------------	-----

ON
OFF

When this Function is ON, the Program Change message sent on the Control Channel works to change the Patch Numbers on the MKS-70.

The Patch Numbers on the MKS-70 correspond to the Program Change Numbers as shown below.

Received Program Change Number	Selected Patch Number
1	1 A1
64	1 H8
65	C A1
128	C H8

22	A	PROG CHANGE	***
----	---	-------------	-----

32	B	PROG CHANGE	***
----	---	-------------	-----

ON
OFF

When the Function 22 is ON, the Program Change message sent on the Channel A changes the Tone A. When the Function 32 is ON, the Program Change sent on the Channel B changes the Tone B.

The Tone Numbers on the MKS-70 correspond to the Program Change Numbers as shown below.

Received Program Change Number	Selected Tone Number
1	1
50	50
100	100

* When either the Channel A or Channel B is set to Control Channel Function ON, the Program Change message sent on that channel will change the Patches.

• Aftertouch

23	A	AFTER TOUCH	***
----	---	-------------	-----

33	B	AFTER TOUCH	***
----	---	-------------	-----

ON
OFF

This Function selects whether to receive or ignore the Aftertouch message.

• MIDI Volume

24	A	MIDI VOLUME	***
----	---	-------------	-----

34	B	MIDI VOLUME	***
----	---	-------------	-----

ON
OFF

This Function selects whether to receive or ignore the MIDI Volume message.

• System Exclusive

14	SISTEM EXCLUSIVE	***
----	------------------	-----

ON
OFF

This Function selects whether to receive or ignore the System Exclusive message.

► For the detailed explanation on the System Exclusive, refer to page 44.

MIDI Function Table

11	MODE
12	CONTROL CHANNEL
13	PATCH PROG CHANGE
14	SYSTEM EXCLUSIVE

21	CHANNEL A	31	CHANNEL B
22	A PROG CHANGE	32	B PROG CHANGE
23	A AFTER TOUCH	33	B AFTER TOUCH
24	A MIDI VOLUME	34	B MIDI VOLUME

2) Setting MIDI Functions

- ① Push the MIDI of the Edit Buttons.
- ② Using the Patch Memory/Number Buttons 1 to 5, assign the number of the MIDI Function to be edited.

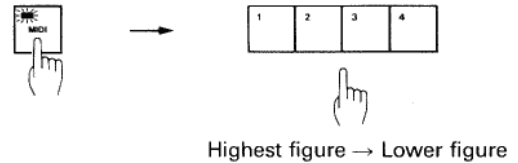

- ③ By rotating the Alpha Dial, change the value.

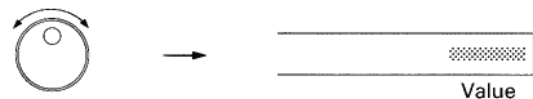

- ④ To continue to edit other MIDI Functions, repeat the steps ② and ③.

► To select a Function, the Alpha Dial can be used instead of the Patch Memory/Number Buttons. Push the MIDI Button then the PARAM Button, then rotate the Alpha Dial until the Function you want appears in the Display. Then push the VALUE of the Edit Buttons and change the value with the Alpha Dial.

- ⑤ When the editing is completed, push the MIDI Button to return to the Playing mode.

The edited data will be retained until the unit is turned off.

4. Writing Mode

Writing mode allows to write the edited data into the internal memory or onto the memory cartridge.

• Protect Switch

To write the data into the internal memory, set the Protect Switch on the MKS-70 to the OFF position, and to write onto the memory cartridge, set the Protect Switch on the cartridge to OFF.

Protect Switch ON

Usually, the Protect Switch should be set to the ON position to prevent accidental loss of the data in memory. With the Protect Switch set to ON, pushing the WRITE Button causes the Display to respond with as shown below, without the data being written.

MEMORY PROTECTED

Protect Switch OFF

OFF position should be selected when writing the data into memory. The switch, however, should be returned to the ON position after writing without fail.

• Memory Cartridge

Patches (A1 to H8), Tones (1 to 50) and MIDI Functions can be written into the memory cartridge.

Before connecting or disconnecting the memory cartridge, be sure to set the Protect Switch on the cartridge to the ON position.

As shown in the picture, securely connect the cartridge to the MKS-70 with the Protect Switch side facing upward.

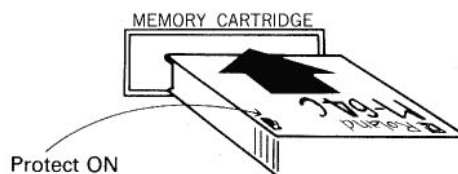

JX-8P's Memory Cartridge

The memory cartridge of the JX-8P "M-16C" can be used as Tone Banks for the MKS-70. The JX-8P has only 32 Tones from Memory Numbers 1 to 32, therefore, assigning other number than 1 to 32 will cause the Display to respond with:

SELECT NO. 1-32

Reassign an appropriate Memory Number.

JX-10's Memory cartridge

The JX-10's memory cartridge for the Voice data (not for the sequencer data) can also be used with the MSK-70. However, the MIDI Functions of the JX-10 cannot be transferred to the MKS-70. Also, writing MIDI Functions on the MKS-70 does not erase the MIDI Functions on the JX-10. The Patch Factors "61-68 MIDI SEND" cannot be used on the MKS-70.

Other Memory Cartridge cannot be used with the MKS-70.

If using any cartridge other than the above two types, the following error message will be shown in the Display.

M I S M A T C H

If you wish to erase the previous data written on the cartridge and write the MKS-70's data on it, take the same Writing procedure twice more. The first time, the Display shows the same indication, and the second time, the writing is executed.

When a brand new cartridge is used, the same error message is shown in the Display. Take the same procedure as above.

■ Writing Procedure

You may normally enter to the Writing mode from the Editing mode, as you may wish to write the edited data. To enter to the Writing mode from the Playing mode, simply push the relevant Edit Button before pushing the WRITE Button.

▶ Pushing the WRITE Button in the Playing mode will cause the Display to respond with:

W R I T E M O D E

Now, push the relevant Edit Button. (The indicator lights up.)

a. Writing a Tone

1 to 50 Tone Numbers can be rewritten, but 51 to 100 are non-volatile. This fact applied to the Tones on the cartridge.

If any of the Tone Numbers 51 to 100 is assigned, the Display responds with:

```
SELECT NO. 1-50
```

Reassign the appropriate Tone Number.

- ① Set the Protect Switch on the destination memory (either the MKS-70 or the cartridge) to the OFF position.
- ② Push the WRITE Button.

```
WRITE TONE TO CART 39 OK?
```

The Tone Number currently in use is shown at the underlined position.

To write the Tone to other Tone Number:

- ③ Select the destination memory (either the internal memory or the memory cartridge) by pushing the Cartridge Button. Then using the Patch Memory/Number Buttons 0 to 9, assign the Tone Number where the Tone is to be written, then push the ENTER Button.
- ④ Push the ENTER Button.

To write the Tone to the Tone Number currently shown in the Display:

```
WRITTEN TONE
```

- ③ Push the ENTER Button.

The Display shows that the writing is completed then returns to the Playing mode indication.

b. Writing a Patch

- ① Set the Protect Switch on the destination memory (either the MKS-70 or the cartridge) to the OFF position.
- ② Push the WRITE Button.

```
WRITE PATCH TO CART A1 OK?
```

The Patch currently in use is shown at the underlined position.

To write the Patch to other location:

- ③ Select the destination memory (either the internal memory or the memory cartridge) by pushing the Cartridge Button. Then using the Patch Memory/Number Buttons 0 to 9, assign the location (Patch) where the Patch is to be written.
- ④ Push the ENTER Button.

To write the Patch to the location (Patch) currently shown in the Display:

- ③ Push the ENTER Button.

```
WRITTEN PATCH
```

The Display shows that the writing is completed then returns to the Playing mode indication.

*** When writing is completed, be sure to return the Protect Switch to the ON position.**

c. Writing MIDI Functions

- ① Set the Protect Switch on the MKS-70 to the OFF position.
- ② Push the WRITE Button.
- ② Push the ENTER Button.
- ③ Return the Protect Switch to the ON position.

* The MIDI Functions cannot be directly written on the cartridge, but can be transferred from the internal memory of the MKS-70.

d. Saving and Loading

The entire data of 64 Patches, 50 Tones and MIDI Functions can be transferred from the internal memory to the memory cartridge (=saving) or vice versa (=loading).

You should enter to the saving or the loading mode from the Playing mode.

● Saving

Saving is transferring the data from the internal memory of the MKS-70 to the memory cartridge.

- ① Make sure that the Protect Switch on the MKS-70 is set to the ON position.
- ② Set the Protect Switch on the memory cartridge to the OFF position.
- ③ Push the WRITE Button.

WRITE MODE

- ④ Rotate the Alpha Dial until the Display responds with:

COPY INTERNALMEMORY TO CARTRIDGE

- ⑤ Push the ENTER Button.

When the saving is done, the Display returns to the Playing mode indication.

- ⑥ Return the Protect Switch on the cartridge to the ON position.

● **Loading**

Loading is the transferring the data from the cartridge to the internal memory.

- ① Make sure that the Protect Switch on the cartridge is set to the ON position.
- ② Set the Protect Switch on the MKS-70 to the OFF position.
- ③ Push the WRITE Button.

WRITE MODE

- ④ Rotate the Alpha Dial until the Display responds with:

COPY CARTRIDGE TO INTERNALMEMORY

- ⑤ Push the ENTER Button.

When the loading is completed, the Display returns to the Playing mode indication.

- ⑥ Return the Protect Switch on the MKS-70 to the ON position.

5. System Exclusive

Using the MIDI System Exclusive, the Patch and Tone data in the MKS-70's internal memory can be transmitted to the receiver device. However, the receiver device must have the function of receiving the data. Here, we use the MKS-70 as a receiver.

To transmit and receive System Exclusive, take the following procedure first.

- ① Match the MIDI Control Channel numbers of the two MKS-70's.
- ② Set the MIDI Function "14 SYSTEM EXCLUSIVE" on the both MKS-70's to ON.

Now, take the following procedure, and the transmitter MKS-70 will transmit the corresponding data, and the receiver will receive it and therefore edited. (Bulk Dump explained later will replace the previous data in the receiver's memory.)

Patch Selection with System Exclusive

- This does not include the Patch selection with the Program Change message.

The whole data of the selected Patch is transmitted:

- Patch Number**
- Patch Name**
- Values of all the Patch Factors**
- Values of all the Parameters of Tone A used in the selected Patch**
- Values of all the Parameters of Tone B used in the selected Patch**

If the receiver MKS-70 is set to the Playing mode, the Display shows the flashing Patch Number and the Tone Numbers of the selected Patch instead of the usual Patch indication.

I-A1 ELECTRIC PIANO 1 39 83.

Flashing

Flashing Flashing

Tone Selection with System Exclusive

- This does not include the Tone selection with the Program Change messages.

The whole data of the selected Tone will be transferred:

Tone Number

Tone Name

Values of Tone Parameters

If the receiver is set to the Playing mode, the selected Tone Number will flash.

I-A1 ELECTRIC PIANO 1	39.	83
-----------------------	-----	----

Flashing

Editing Patch Factors or Tone Parameters with System Exclusive

The edited values of the Patch Factors or Tone Parameters are transferred.

If the receiver is in the Playing mode, the selected Patch Number or the Tone Number(s) flashes.

• Bulk Damp

Bulk Damp is transferring all the 64 Patches and 50 Tones stored in the internal memory to the receiver device.

- * While in Bulk Damp, the MKS-70 cannot be played.

<How to Bulk Damp>

Set the Protect Switch on the receiver to the OFF position, then take the following procedure on the transmitter.

- ① Push the MIDI Button.

The indicator on the MIDI Button lights up.

- ② Push the WRITE Button.

The Display responds with:

WRITE MIDI

- ③ Rotate the Alpha Dial until the Display responds with:

MIDI BULK DUMP

- ④ Push the ENTER Button.

Now, Bulk Damp is executed, and the Display of the receiver responds with:

MIDI BULK LOAD

- * While the above indication is shown in the Display, the MKS-70 cannot be played.

- * Return the Protect Switch on the receiver to the ON position.

3 ERROR MESSAGES

1) MEMORY PROTECTED

When this error message is shown in the Display, the Protect Switch of the destination memory is set to the On position (during the Writing mode).

Set the relevant Protect Switch to the OFF position, and repeat the writing procedure.

2) INSERT CARTRIDGE

The cartridge is not properly connected.

Securely and correctly connect the cartridge to the MKS-70, and repeat the procedure.

3) MISMATCH

The cartridge connected is not appropriate for what you are going to do. Change the cartridges.

However, if you want to erase the previous data and write on that cartridge, take the same writing procedure two more times. The first time, the same indication "MISMATCH" is shown, and the second time, writing is done.

When a brand new cartridge is used, the same error message is shown. Do exactly the same as above.

4) NOT M-64C

This is shown when you try to write Patch, Tone or MIDI data onto the M-16C cartridge. Change it to the M-64C cartridge.

5) SELECT NO.1-50

This appears when you try to write a Tone Number 51 to 100 which can be edited but cannot be rewritten. Select the Tone Number 1 to 50.

6) SELECT NO.1-32

When you try to call a Tone other than 1 to 32 from the JX-8P's memory cartridge, this error message appears in the Display. Select the Tone Number 1 to 32.

7) MEMORY ERR

The data is not properly written into memory. If this error message is frequently shown, ask for your local Roland service station.

MODEL MKS-70 MIDI Implementation Chart

Function.....		Transmitted	Recognized	Remarks
Basic Channel	Default	X	1-16	memorized
	Changed	X	1-16	
Mode	Default	X	Mode 3, Mode 4 POLY, MONO	memorized
	Messages	X		
	Altered	*****		
Note Number	True voice	X	0-127	
		*****	21-108	
Velocity	Note ON	X	○ v=1-127	
	Note OFF	X	X	
After Touch	Key's	X	X	
	Ch's	X	*	
Pitch Bender		X	* 2/3/4/7/12 semi 8bits reso.	
Control Change	1	X	○	Modulation Portamento time Volume Hold 1 Portamento Switch
	5	X	○	
	7	X	*	
	64	X	○	
	65	X	○	
Prog Change	True #	* 0-99 (0-127) 0-99 (0-127)	* 0-99 (0-127) 0-99 (0-127)	**
System Exclusive		*	*	
System Common	Song Pos	X	X	
	Song Sel	X	X	
	Tune	X	X	
System Real Time	Clock	X	X	
	Commands	X	X	
Aux Messages	Local ON/OFF	X	X	
	All Notes OFF	X	○ (123-127)	
Mes-sages	Active Sense	X	X	
	Reset	X	X	
Notes		* Can be set to ○ or X manually, and memorized. ** As tone # : 0-99(100-127 ignored if received.) As patch # : 0-127 See implementation notes for details.		

Mode 1 : OMNI ON, POLY
Mode 3 : OMNI OFF, POLY

Mode 2 : OMNI ON, MONO
Mode 4 : OMNI OFF, MONO

○ : Yes
X : No

MODEL MKS-70 MIDI Implementation

1. TRANSMITTED DATA

Status	Second	Third	Description
1100 nnnn	0ppp pppp		Program Change ppppppp = 0 - 127 (0 - 99)

Notes : Program Change (TONE #) are transmitted on CHANNEL A and/or channel B according to KEY MODE.
Program Change (PATCH #) are transmitted on CONTROL CHANNEL

- a. On CHANNEL A OR CHANNEL B :
TONE # is Transmitted if the corresponding function switch is ON.
ppppppp = 0 - 99 : TONE No. 1 - 100
- b. On CONTROL CHANNEL :
PATCH # is Transmitted if the corresponding function switch is ON.
ppppppp = 0 - 63 : Internal Memory PATCH A1 - H8
64 - 127 : Cartridge Memory PATCH A1 - H8

2. RECOGNIZED RECEIVE DATA

Status	Second	Third	Description
1000 nnnn	0kkk kkkk	0vvv vvvv	Note OFF, velocity ignored
1001 nnpn	0kkk kkkk	0000 0000	Note OFF kkkkkkk = 0 - 127 (21 - 108) #1
1001 nnnn	0kkk kkkk	0vvv vvvv	Note ON kkkkkkk = 0 - 127 (21 - 108) #1 vvvvvvv = 1 - 127
1011 nnnn	0000 0001	0vvv vvvv	Modulation vvvvvvv = 0 - 127
1011 nnnn	0000 0101	0vvv vvvv	Portamento time vvvvvvv = 0 - 127
1011 nnnn	0000 0111	0vvv vvvv	Volume vvvvvvv = 0 - 127 #2
1011 nnnn	0100 0000	01xx xxxx	Hold 1 ON
1011 nnnn	0100 0000	00xx xxxx	Hold 2 OFF
1011 nnnn	0100 0001	01xx xxxx	Portamento ON
1011 nnnn	0100 0001	00xx xxxx	Portamento OFF
1100 nnnn	0ppp pppp		Program Change ppppppp = 0 - 127 (0 - 99) #2,#3
1101 nnnn	0vvv vvvv		Channel After Touch vvvvvvv = 0 - 127 #2
1110 nnnn	0vvv vvvv	0vvv vvvv	Pitch Bender Change #2
1011 nnnn	0111 1110	000m mmmm	Mono ON #2
1011 nnnn	0111 1111	0000 0000	Poly ON #2
1011 nnnn	0111 1011	0000 0000	ALL NOTES OFF #2

Notes : All messages except PATCH # (Program Change) are received from CHANNEL A and/or CHANNEL B according to KEY MODE.

#1 Note numbers outside of the range 21 - 108 are transposed to the nearest octave inside this range.

#2 Received if the corresponding function switch is ON.

- #3 a. ON CHANNEL A OR CHANNEL B :
Received as TONE # if the corresponding function switch is ON.
ppppppp = 0 - 99 : TONE No. 1 - 100
- b. ON CONTROL CHANNEL :
Received as PATCH # if the corresponding function switch is ON.
ppppppp = 0 - 63 : Internal Memory PATCH A1 - H8
64 - 127 : Cartridge Memory PATCH A1 - H8

3. TRANSMITTED EXCLUSIVE MESSAGES

3.1 When the 'Patch Bank' or 'Patch Number' is changed, the following exclusive messages (3.1.1 PGR and 3.1.2 APR) are sent in sequence.

3.1.1 Program Number (PGR)

Byte	Description
a 1111 0000	Exclusive status
b 0100 0001	Roland ID #
c 0011 0100	Operation code = PGR (program number)
d 0000 nnnn	Unit # = control channel, nnnn = 0 - 15 where nnnn + 1 = channel #
e 0010 0100	Format type (JX-10)
f 0011 0000	Level 2 Patch
g 0000 0001	Group #
h 0000 0000	PG# indicates the patch number
i 00pp pppp	Patch number
j 0000 0000	NOP
k 1111 0111	End of System Exclusive

3.1.2 All Patch Parameters (APR)

Byte	Description
a 1111 0000	Exclusive status
b 0100 0001	Roland ID #
c 0011 0101	Operation code = APR (all parameters)
d 0000 nnnn	Unit # = control channel, nnnn = 0 - 15 where nnnn + 1 = channel #
e 0010 0100	Format type (JX-10)
f 0011 0000	Level 2 Patch
g 0000 0001	Group #
h 0vvv vvvv	Value (0 - 127)
:	In sequence (51 byte total)
i 1111 0111	End of System Exclusive

3.2 Individual Patch Parameter (IPR)

When the Patch Memory Factor is changed.

Byte	Description
a 1111 0000	Exclusive status
b 0100 0001	Roland ID #
c 0011 0110	Operation code = IPR (individual parameter)
d 0000 nnnn	Unit # = control channel, nnnn = 0 - 15 where nnnn + 1 = channel #
e 0010 0100	Format type (JX-10)
f 0011 0000	Level 2 Patch
g 0000 0001	Group #
h 00pp pppp	Parameter # (0 - 51)
i 0vvv vvvv	Value (0 - 127)
:	h and i (repeatedly)
j 1111 0111	End of System Exclusive

Notes :

parameter #	Function	Value
0-17	PATCH NAME 1..18	In ASCII
18	U/L BALANCE	0 - 127
19	DUAL DETUNE	0 - 127
20	UPPER SPLIT POINT	21 - 108
21	LOWER SPLIT POINT	21 - 108
22	PORTAMENTO TIME	0 - 127
23	BEND RANGE 0aaaaaaa	0,32,64,96
52	BEND RANGE 0bbbbbbb	0,1
	BEND RANGE = bbbbbbaaaaaaa	
		0 = 2 Semi Tones
		32 = 3 Semi Tones
		64 = 4 Semi Tones
		96 = 7 Semi Tones
		128 = 12 Semi Tones
		160 = 12 Semi Tones
		192 = 12 Semi Tones
		224 = 12 Semi Tones
24	KEY MODE 000000aa	0 - 2
51	KEY MODE 000000bb	0 - 2
	KEY MODE = bbaa	0 = DUAL
		1 = SPLIT
		2 = A WHOLE
		3 = B WHOLE
		4 = X - FADE
		8 = T - VOICE
25	TOTAL VOLUME	0 - 127
26	AFTER TOUCH VIBRATO	0 - 127
27	AFTER TOUCH BRILLIANCE	0 - 127
28	AFTER TOUCH VOLUME	0 - 127
29	UPPER TONE NUMBER	0 - 99
30	UPPER CHROMATIC SHIFT	0 - 24 = 0 - (+24) semi tones
		104 - 127 = (-24) - (-1) semi tones
31	UPPER KEY ASSIGN	0 = Poly-1
		1 = Unison-1
		2 = Mono-1
		4 = Poly-2
		5 = Unison-2
		6 = Mono-2
32	UPPER UNISON DETUNE	0 - 127
33	UPPER HOLD	0 = OFF
		1 = ON
34	UPPER LFO MOD DEPTH	0 - 127
35	UPPER PORTAMENTO	0 = OFF
		1 = ON
36	UPPER BENDER	0 = OFF
		1 = ON
37	Undefined	
38	LOWER TONE NUMBER	0 - 99
39	LOWER CHROMATIC SHIFT	0 - 24 = 0 - (+24) semi tones
		104 - 127 = (-24) - (-1) semi tones
40	LOWER KEY ASSIGN	0 = Poly-1
		1 = Unison-1
		2 = Mono-1
		4 = Poly-2
		5 = Unison-2
		6 = Mono-2
41	LOWER UNISON DETUNE	0 - 127
42	LOWER HOLD	0 = OFF
		1 = ON
43	LOWER LFO MOD DEPTH	0 - 127
44	LOWER PORTAMENTO	0 = OFF
		1 = ON
45	LOWER BENDER	0 = OFF
		1 = ON
46	Undefined	
47	CHASE LEVEL	0 - 127
48	CHASE MODE	0 = A-B
		1 = A-B-B-
		2 = A-B-A-
49	CHASE TIME	1 - 127
50	CHASE PLAY	0 = OFF
		1 = ON

3.3 When the 'Tone Number' is changed, the following exclusive messages (3.3.1 PGR and 3.3.2 APR) are sent in sequence.

3.3.1 Program Number (PGR)

Byte	Description
a 1111 0000	Exclusive status
b 0100 0001	Roland ID #
c 0011 0100	Operation code = PGR (program number)
d 0000 nnnn	Unit # = control channel, nnnn = 0 - 15 where nnnn + 1 = channel #
e 0010 0100	Format type (JX-10)
f 0010 0000	Level 1 Tone
g 0000 00gg	Group # gg = 01 Tone A gg = 10 Tone B
h 0000 0000	PG# indicates the tone number
i 00tt tttt	Tone number
j 0000 0000	NOP
k 1111 0111	End of System Exclusive

3.3.2 All Tone Parameters (APR)

Byte	Description
a 1111 0000	Exclusive status
b 0100 0001	Roland ID #
c 0011 0101	Operation code = APR (all parameters)
d 0000 nnnn	Unit # = control channel, nnnn = 0 - 15 where nnnn + 1 = channel #
e 0010 0100	Format type (JX-10)
f 0010 0000	Level # = 1
g 0000 00gg	Group # gg = 01 Tone A gg = 10 Tone B
h 0vVV vvvv	Value (0 - 127)
:	In sequence (59 byte total)
i 1111 0111	End of System Exclusive

3.4 Individual Tone Parameter (IPR)
When the Parameter is changed.

Byte	Description
a 1111 0000	Exclusive status
b 0100 0001	Roland ID #
c 0011 0110	Operation code = IPR (individual parameter)
d 0000 nnnn	Unit # = control channel, nnnn = 0 - 15 where nnnn + 1 = channel #
e 0010 0100	Format type (JX-10)
f 0010 0000	Level # = 1
g 0000 00gg	Group # gg = 01 Tone A gg = 10 Tone B
h 00pp pppp	Parameter # (0 - 58)
i 0vVV vvvv	Value (0 - 127)
:	h and i (repeatedly)
j 1111 0111	End of System Exclusive

Notes :

Parameter #	Function	Value
0-9	NAME-0..9	In ASCII
10	Undefined	
11	DCO-1 RANGE	0 - 31 = 16' 32 - 63 = 8' 64 - 95 = 4' 96 - 127 = 2'
12	DCO-1 WAVEFORM	0 - 31 = Noise 32 - 63 = Sawtooth Wave 64 - 95 = Pulse Wave 96 - 127 = Square Wave
13	DCO-1 TUNE	0 - 127 (-1 oct -- +1 oct)
14	DCO-1 LFO MOD DEPTH	0 - 127
15	DCO-1 ENV MOD DEPTH	0 - 127
16	DCO-2 RANGE	0 - 31 = 16' 32 - 63 = 8' 64 - 95 = 4' 96 - 127 = 2'
17	DCO-2 WAVEFORM	0 - 31 = Noise 32 - 63 = Sawtooth Wave 64 - 95 = Pulse Wave 96 - 127 = Square Wave
18	DCO-2 CROSSMOD	0 - 31 = OFF 32 - 63 = SYNC 1 64 - 95 = SYNC 2 96 - 127 = XMOD (cross modulation)
19	DCO-2 TUNE	0 - 127 (-1 oct -- +1 oct)
20	DCO-2 FINE TUNE	0 - 127 (-50 cent -- +50 cent)
21	DCO-2 LFO MOD DEPTH	0 - 127
22	DCO-1 ENV MOD DEPTH	0 - 127
23	Undefined	
24	Undefined	
25	Undefined	
26	DCO DYNAMICS	0 - 31 = OFF 32 - 63 = 1 64 - 95 = 2 96 - 127 = 3
27	DCO ENV MODE	0 - 31 = ENV-2 Inverted 32 - 63 = ENV-2 Normal 64 - 95 = ENV-1 Inverted 96 - 127 = ENV-1 Normal
28	MIXER DCO-1	0 - 127
29	MIXER DCO-2	0 - 127
30	MIXER ENV MOD DEPTH	0 - 127
31	MIXER DYNAMICS	0 - 31 = OFF 32 - 63 = 1 64 - 95 = 2 96 - 127 = 3
32	MIXER ENV MODE	0 - 31 = ENV-2 Inverted 32 - 63 = ENV-2 Normal 64 - 95 = ENV-1 Inverted 96 - 127 = ENV-1 Normal
33	HPF CUTOFF FREQ	0 - 31 = 0 32 - 63 = 1 64 - 95 = 2 96 - 127 = 3

34	VCF CUTOFF FREQ	0 - 127
35	VCF RESONANCE	0 - 127
36	VCF LFO MOD DEPTH	0 - 127
37	VCF ENV MOD DEPTH	0 - 127
38	VCF KEY FOLLOW	0 - 127
39	VCF DYNAMICS	0 - 31 = OFF 32 - 63 = 1 64 - 95 = 2 96 - 127 = 3
40	VCF ENV MODE	0 - 31 = ENV-2 Inverted 32 - 63 = ENV-2 Normal 64 - 95 = ENV-1 Inverted 96 - 127 = ENV-1 Normal
41	VCA LEVEL	0 - 127
42	VCA DYNAMICS	0 - 31 = OFF 32 - 63 = 1 64 - 95 = 2 96 - 127 = 3
43	CHORUS	0 - 31 = OFF 32 - 63 = 1 64 - 127 = 2
44	LFO WAVEFORM	0 - 31 = Random 32 - 63 = Square Wave 64 - 127 = Triangle Wave
45	LFO DELAY TIME	0 - 127
46	LFO RATE	0 - 127
47	ENV-1 ATTACK TIME	0 - 127
48	ENV-1 DECAY TIME	0 - 127
49	ENV-1 SUSTAIN LEVEL	0 - 127
50	ENV-1 RELEASE TIME	0 - 127
51	ENV-1 KEY FOLLOW	0 - 31 = OFF 32 - 63 = 1 64 - 95 = 2 96 - 127 = 3
52	ENV-2 ATTACK TIME	0 - 127
53	ENV-2 DECAY TIME	0 - 127
54	ENV-2 SUSTAIN LEVEL	0 - 127
55	ENV-2 RELEASE TIME	0 - 127
56	ENV-2 KEY FOLLOW	0 - 31 = OFF 32 - 63 = 1 64 - 95 = 2 96 - 127 = 3
57	Undefined	
58	VCA ENV MODE	0 - 63 = Gate 64 - 127 = ENV-2 Normal

3.5 Bulk Dump (BLD)

- * How to enter to 'BULK DUMP' mode :
1. Press both MIDI and WRITE button.
2. Select BULK DUMP by ALPHA-DIAL, then press ENTER.

3.5.1 Bulk Dump [PATCH]

Byte	Description
a 1111 0000	Exclusive status
b 0100 0001	Roland ID #
c 0011 0111	Operation code = BLD (bulk dump)
d 0000 nnnn	Unit # = control channel, nnnn = 0 - 15 where nnnn + 1 = channel #
e 0010 0100	Format type (JX-10)
f 0011 0000	Level # = 2 Patch
g 0000 0001	Group #
h 0000 0000	PG# indicates the Patch number
i 00pp pppp	Patch number (0 - 63)
j 0000 vvvv	Value (0 - 15)
:	in sequence (96 bytes total)
k 1111 0111	End of System Exclusive

Notes :

Bulk Dump [PATCH] is available the Internal Memory PATCH A1 - H8(pppppp = 0 - 63) only.

3.5.2 Bulk Dump [TONE]

Byte	Description
a 1111 0000	Exclusive status
b 0100 0001	Roland ID #
c 0011 0111	Operation code = BLD (bulk dump)
d 0000 nnnn	Unit # = control channel, nnnn = 0 - 15 where nnnn + 1 = channel #
e 0010 0100	Format type (JX-10)
f 0010 0000	Level # = 1 Tone
g 0000 0001	Group #
h 0000 0000	PG# indicates the Tone
i 00tt tttt	Tone number (0 - 49)
j 0vVV vvvv	Value (0 - 127)
:	in sequence (59 bytes total)
k 1111 0111	End of System Exclusive

Notes :

Bulk Dump [TONE] is available the Internal Memory TONE # 1 - 50 (ttttt = 0 - 49) only.

3.5.3 Sequence of Bulk Dump

- 1: Bulk Dump [PATCH] message repeats 64 times.
- 2: Bulk Dump [TONE] message repeats 50 times.

4. RECOGNIZED EXCLUSIVE MESSAGES

All Exclusive messages described in section 3.

MKS-70 Operation Table

Play Mode

Changing Patches

A	B	C	D	E	F	G	H
1	2	3	4	5	6	7	8

Quick Edit

1. Changing Key Modes

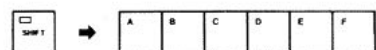

2. Changing Tone Numbers

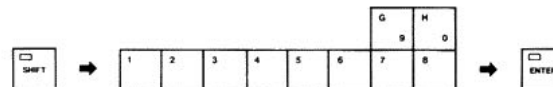

3. Turning Chase Play on or off



Function Display



Patches

Tones

MIDI

Master Tune

Edit Mode

Patch Editing

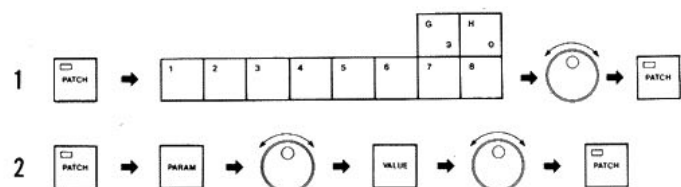

Tone Editing

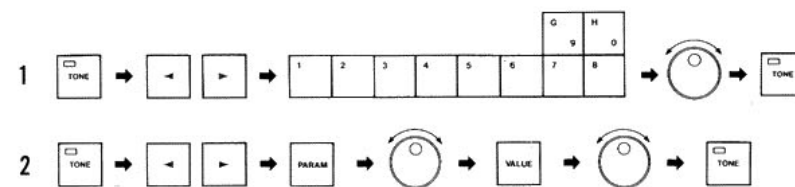

MIDI Editing

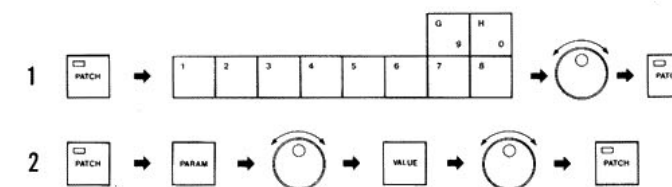

Master Tune



Patch Naming

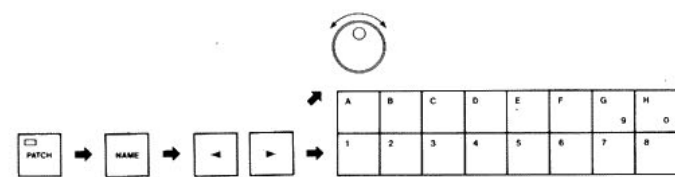

Tone Naming

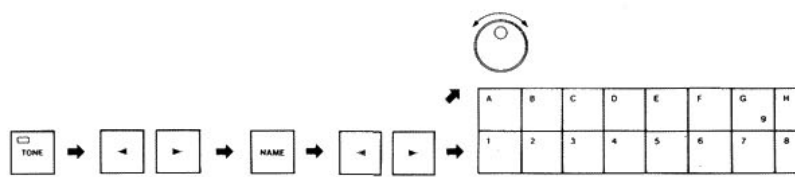

Write Mode

Patch Writing

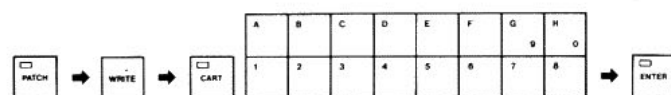

Tone Writing

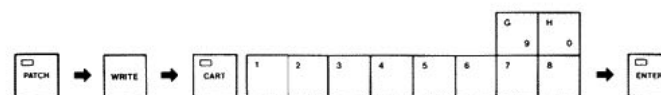

MIDI Writing

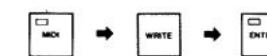

Writing Master Tune



Copying

Saving



Loading

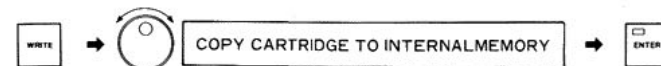

Bulk Dump



SPECIFICATIONS

MKS-70: 12 Voices (24 DCO's) Polyphonic Synthesizer Module

Memory

- a. Patch
 - Internal Memory: 64
 - (Memory Cartridge): 64
- b. Tone
 - Preset: 50
 - Internal Memory: 50
 - (Memory Cartridge): 50

Edit

- Patch Factors
- Tone Parameter
- MIDI Functions
- Master Tune
- Name

Front Panel

- Patch Memory/Number (A – H, 1 – 8) Buttons
- Edit Buttons (PATCH, TONE, MIDI, PARAM, VALUE, NAME)

- Function Display Button
- A/B Buttons
- Chase Play Button
- Write Button
- Ten Key Pad
- Enter Button
- Master Tune Button
- Volume Knob
- Alpha Dial
- Protect Switch
- Power Switch
- Programmer Connector
- Headphones Jack
- 32 figures Fluorescent Indicator Panel Display

Rear Panel

- Mix Output Jack
- Output Level Switch
- Parallel Output Jack × 4
- MIDI Connector × 3

Dimensions: 480 (W) × 400 (D) × 88 (H) mm/
18-7/8" × 15-3/4" × 3-7/16"

Weight: 7.6 kg / 70 lb 10 oz

Power Consumption: 32 W

Accessories

- Connection Cord × 2
- MIDI Cable
- Memory Cartridge M-64C × 1
- Edit Map
- Owner's Manual
- Guide Book "MIDI"

OPTIONS

- Programmer PG-800
- Memory Cartridge M-64C
- Carrying Case

